

# VT100 User Guide



Transferred Into PDF Format By:

Edwin Rhodes (PIE Software Inc 2004)

## Contents

### Chapter 1 - Operator Information

- Part 1 -- Keyboard Control and Indicators
  - Monitor Controls
    - Audible Indicators (Tones)
- Part 2 -- Set-Up Mode
  - SET-UP Features at a Glance
  - Determining What a SET-UP Feature Does
  - How To Change a SET-UP Feature
  - Setting the Answerback Message
  - Saving the SET-UP Features
  - Recalling SET-UP Features
  - Resetting the Terminal
- Part 3 -- Definition of Each SET-UP Feature
- Part 4 -- Self-Testing the VT100
  - Self-Test Error Codes
- Part 5 -- What To Do in the Event of a Problem

### Chapter 2 - Installation, Interface Information and Specifications

- Installation
  - Site Considerations
  - Unpacking and Maintenance
  - User Maintenance
- Interface Information
  - EIA Interface
    - Electrical Characteristics
  - Optional 20 mA Current Loop Interface
  - External Video Connections
- VT100 Specifications
- How to Order Hardware Documentation

### Chapter 3 - Programmer Information

- The Keyboard
- Communications Protocols
- Terminal Control Commands
  - Control Characters
  - Control Sequences
  - Valid ANSI Mode Control Sequences
    - CPR -- Cursor Position Report -- VT100 to Host
    - CUB -- Cursor Backward -- Host to VT100 and VT100 to Host
    - CUD -- Cursor Down -- Host to VT100 and VT100 to Host
    - CUF -- Cursor Forward -- Host to VT100 and VT100 to Host
    - CUP -- Cursor Position

- CUU -- Cursor Up -- Host to VT100 and VT100 to Host
- DA -- Device Attributes
- DECALN -- Screen Alignment Display (DEC Private)
- DECANM -- ANSI/VT52 Mode (DEC Private)
- DECARM -- Auto Repeat Mode (DEC Private)
- DECAWM -- Autowrap Mode (DEC Private)
- DECCKM -- Cursor Keys Mode (DEC Private)
- DECCOLM -- Column Mode (DEC Private)
- DECDHL -- Double Height Line (DEC Private)
- DECDWL -- Double-Width Line (DEC Private)
- DECID -- Identify Terminal (DEC Private)
- DECINLM -- Interlace Mode (DEC Private)
- DECKPAM -- Keypad Application Mode (DEC Private)
- DECKPNM -- Keypad Numeric Mode (DEC Private)
- DECLL -- Load LEDS (DEC Private)
- DECOM -- Origin Mode (DEC Private)
- DECRC -- Restore Cursor (DEC Private)
- DECREPTPARM -- Report Terminal Parameters
- DECREQTPARM -- Request Terminal Parameters
- DECSC -- Save Cursor (DEC Private)
- DECSCLM -- Scrolling Mode (DEC Private)
- DECSCNM -- Screen Mode (DEC Private)
- DECSTBM -- Set Top and Bottom Margins (DEC Private)
- DECSWL -- Single-width Line (DEC Private)
- DECTST -- Invoke Confidence Test
- DSR -- Device Status Report
- ED -- Erase In Display
- EL -- Erase In Line
- HTS -- Horizontal Tabulation Set
- HVP -- Horizontal and Vertical Position
- IND -- Index
- LNM -- Line Feed/New Line Mode
- NEL -- Next Line
- RI -- Reverse Index
- RIS -- Reset To Initial State
- RM -- Reset Mode
- SCS -- Select Character Set
- SGR -- Select Graphic Rendition
- SM -- Set Mode
- TBC -- Tabulation Clear
- Modes
- Valid VT52 Mode Control Sequences
  - Cursor Up
  - Cursor Down
  - Cursor Right
  - Cursor Left

- Enter Graphics Mode
- Exit Graphics Mode
- Cursor to Home
- Reverse Line Feed
- Erase to End of Screen
- Erase to End of Line
- Direct Cursor Address
- Identify
- Enter Alternate Keypad Mode
- Exit Alternate Keypad Mode
- Enter ANSI Mode
- Control Sequence Summary
  - ANSI Compatible Mode
  - VT52 Compatible Mode

## Chapter 4 - VT100 Options

- Advanced Video Option -- VT1XX-AB
  - Advanced Video Option Installation
  - Advanced Video Option Checkout
- 20 mA Current Loop Option -- VT1XX-AA
  - 20 mA Current Loop Option Installation
  - 20 mA Current Loop Option Checkout
- Communications Cables

## Chapter 5 - Accessories and Supplies

Appendix A - ANSI Definitions and Notation

Appendix B - 7-Bit ASCII Code

Appendix C - Fill Character Requirements

## Figures

- 1-1 VT100 Terminal
- 1-2 VT100 Keyboard
- 1-3 VT100 Terminal (Rear View)
- 1-4 SET-UP A Mode Presentation
- 1-5 SET-UP B Mode Presentation
- 1-6 SET-UP B Mode Summary
- 2-1 VT100 Terminal Dimensions
- 2-2 VT100 Rear View
- 2-3 20 mA Current Loop Interface
- 2-4 Composite Video Output
- 3-1 Terminal Data Flow
- 3-2 VT100 Keyboard
- 4-1 VT100 Rear View
- 4-2 Advanced Video Option Installation
- 4-3 20 mA Current Loop Option
- 4-4 Terminal Controller Board

## Tables

- 1-1 Categories of SET-UP Features

- 1-2 SET-UP Feature Change Summary
- 1-3 Nonfatal Displayed Error Codes
- 1-4 Problem Checklist
- 2-1 EIA RS-232-C Connector Signals
- 3-1 Machine States
- 3-2 Alphabetic Key Codes
- 3-3 Nonalphabetic Key Codes
- 3-4 Function Key Codes
- 3-5 Control Codes Generated
- 3-6 Cursor Control Key Codes
- 3-7 VT52 Mode Auxiliary Keypad Codes
- 3-8 ANSI Mode Auxiliary Keypad Codes
- 3-9 Special Graphics Characters
- 3-10 Control Characters
- C-1 Fill Character Requirements

## **Chapter 1**

### **Operator Information**

The VT100 is a simple device to operate. The terminal (Figure 1-1) is basically a typewriter that uses a video screen instead of paper and communicates with a computer. If you can operate a typewriter, you can operate a VT100. Chapter 1 is divided into five parts:

1. Controls and Indicators
2. Setup Mode
3. Definition of Each Setup Feature
4. Self-Testing the VT100
5. What to do in the Event of a Problem

Part 1 shows all the controls and indicators on the terminal and summarizes the function of each, thus providing a quick reference for these functions.

Part 2 defines the SET-UP mode and briefly summarizes its features.

Part 3 describes each feature in detail. Refer to this section if you need further information on a feature mentioned in the SET-UP Summary provided in Part 2.

Part 4 provides information on self-testing the VT100. It outlines the steps required to start the built-in self-tests and how to interpret the results once the tests have been run.

Part 5 provides a procedure to follow in case you encounter any problem with the VT100. Easily recognized failures with simple corrective actions are provided for each symptom. Check the list on page 18 before calling for service.

#### **Part 1 -- Keyboard Control and Indicators**

The VT100 terminal normally performs a two-part function. It is an input device to a computer -- information entered through the keyboard is sent to the computer. It is simultaneously an output device for the computer -- that is, data coming in from the computer is displayed on the video screen. The following controls and indicators on the VT100 keyboard are illustrated in [Figure 1-2](#).

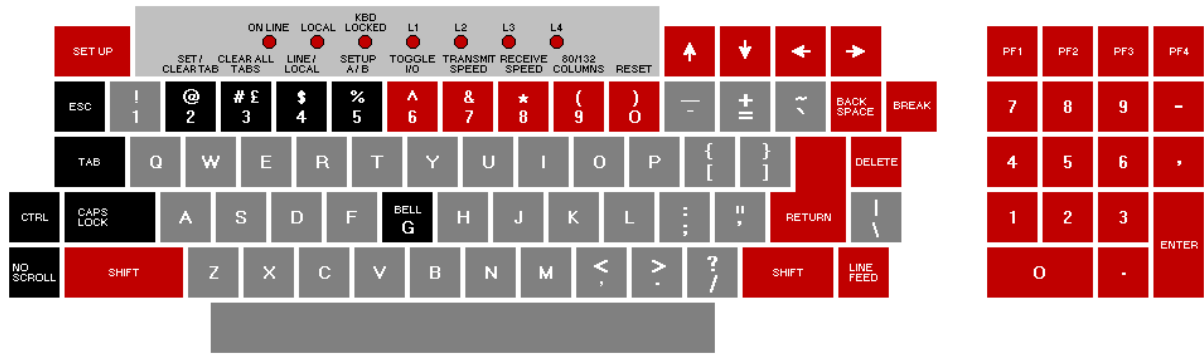

SETUP

This key is used in conjunction with other keys to perform specific functions such as setting tabs, scrolling, and altering terminal characteristics.

#### ON LINE

This indicator lights to show that the VT100 is on-line and ready to transmit or receive messages.

#### LOCAL

This indicator lights to show that the terminal is off-line and cannot communicate with the host device. In local mode the keyboard remains active and all characters typed are placed on the screen.





#### KEYBOARD LOCKED

This indicator lights to show that the keyboard has been turned off. The VT100 is still able to receive data from the host. This condition can be cleared by entering and exiting SET-UP mode.

#### L1--L4

These indicators are turned on and off by the host. Consult your local operating procedures for the meaning of each indicator. L1--L4 are also used to show self-test errors.



Each of these keys causes the VT100 to transmit a code which has a special meaning to your system. Consult your local operating procedures for the meaning of these keys. In SET-UP mode the  and  keys increase or decrease the brightness of the display. The  and  keys move the cursor left and right.



BACKSPACE

This key transmits a backspace code.



BREAK

This key transmits a break signal.



PF1 - PF4

Each of these keys causes the VT100 to transmit a code which has a special meaning to your system. Consult your local operating procedures for the meanings of these keys.

#### Numeric Keypad

The numeric keypad enables numbers to be entered in calculator fashion. Each key in the numeric keypad generates the same character as the corresponding numeric key on the main keyboard. The ENTER key corresponds to the RETURN key. These keys may also be interpreted by the host computer as special function keys. Consult your local operating procedures for the meanings of these keys.



DELETE

This key causes the VT100 to transmit a delete character code to the host system. The deleted character may or may not be erased from the screen.



RETURN

This key transmits either a carriage return (CR) code or a carriage return (CR) and linefeed (LF) code. This is a SET-UP selectable feature.



LINEFEED

This key transmits a linefeed code.



SHIFT

When pressed, this key enables the uppercase function of all keys. If a key does not have an uppercase function the SHIFT key will be disregarded.



RESET

When the terminal is in SET-UP mode, this key starts the reset sequence. This has the same result as turning the terminal power off and then on.



80/132 COLUMNS

When the terminal is in SET-UP A mode, this key switches the display line size from 80 to 132 characters per line or from 132 to 80 characters per line.



RECEIVE SPEED

When the terminal is in SET-UP B mode, this key steps the

terminal through the receive baud rate settings in ascending order.

**&  
7** TRANSMIT SPEED

When the terminal is in SET-UP B mode, this key steps the terminal through the transmit baud rate settings in ascending order.

**^  
6** TOGGLE 1/0

When the terminal is in SET-UP B mode, this key turns the selected operational feature on or off.

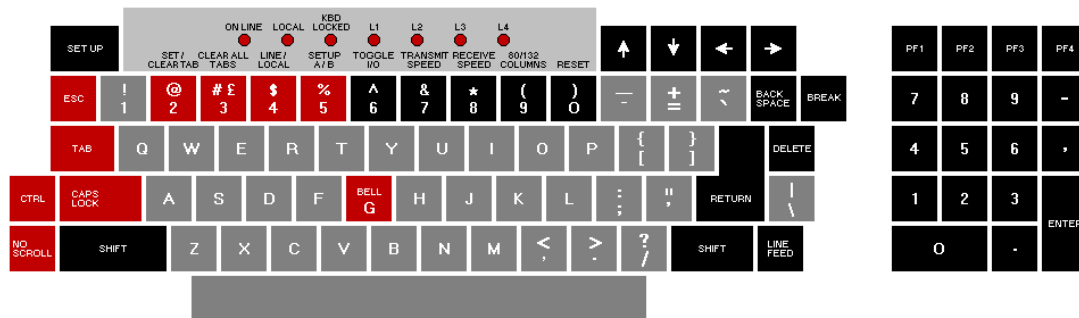

**BELL  
G** BELL G

When pressed in combination with the CTRL key, this key causes a bell code to be sent to the host.

**%  
5** SET-UP A/B

When the terminal is in SET-UP mode, this key switches the terminal from SET-UP A to SET-UP B or from SET-UP B to SET-UP A.

**\$  
4** LINE/LOCAL

In SET-UP mode, this key alternately places the VT100 ON LINE or LOCAL to your system. When it is ON LINE, the VT100 communicates with your system. When it is in LOCAL the VT100 is electrically disconnected from your system.

**# £  
3** CLEAR ALL TABS

In SET-UP A, this key clears all horizontal tabs set in the VT100.

**@  
2** SET/CLEAR TAB

In SET-UP A, this key sets or clears individual horizontal tabs.

**CAPS  
LOCK** CAPS LOCK

This key enables the transmission of uppercase alphabetic

characters only. All numeric and special symbol keys remain in lowercase.

NO  
SCROLL

NO SCROLL

When first pressed, this key stops the transmission of data from the computer to the VT100. When pressed a second time, transmission resumes from where it was stopped. Check your local operating procedures to ensure that your system recognizes this key.

CTRL

CTRL

When pressed in combination with another key, the CTRL key causes the VT100 to transmit a code which has a special meaning to your system.

TAB

TAB

This key transmits a tab code.

ESC

ESC

This key transmits a code which normally has a special meaning to your system. In many applications, it tells your system to treat the next keys pressed as a command.

## Monitor Controls

The VT100 monitor contains only two controls: the power switch and the power selector switch, which is used to adapt the terminal to the available ac input voltage range (see specifications).

## Audible Indicators (Tones)

There are three audible alarms associated with the VT100: a short tone (click), a long tone (bell), and a series of long tones.

Short Tone (Click) -- The short tone is sounded by the terminal whenever a key is pressed, with the following exceptions:

- SHIFT or CTRL keys do not generate any keyclick because these keys do not transmit any codes but only modify the codes transmitted by other keys.
- KBD LOCKED indicator is turned on; in which case, the characters typed are lost.
- The keyclick feature has been turned off in SET-UP mode.

Long Tone (Bell) -- The long tone is sounded by the terminal to indicate one of the following conditions:

- A bell code was received from the computer.
- The cursor is eight characters away from the right margin and the margin bell feature is enabled.

Series of Long Tones -- The terminal will sound the long tone several times in rapid succession to indicate that the nonvolatile memory (NVR) had difficulty in reading or writing the SET-UP features. (When this occurs, check the SET-UP features and then perform the Recall or Save operation again.)

## **Part 2 -- Set-Up Mode**

Unlike most terminals, the VT100 does not use switches or jumpers to individually turn the built-in terminal features on or off. Instead, the VT100 uses a nonvolatile memory (NVR) which always remembers what features have been selected, as if a switch had been set.

The selection and storage of built-in terminal features is performed in a special mode of operation called SET-UP mode. When you enter SET-UP mode, the status of the features stored in the temporary memory is shown on the screen. You can then change the features and store any new feature selections either temporarily, by leaving SET-UP mode; or on a fixed basis, by performing a Save operation. In either case, the terminal operation will reflect the new feature selection. If a recall operation is performed, or the terminal is reset, or the terminal power is turned OFF, all temporary feature settings are replaced by the features that have been stored on a fixed basis.

### **SET-UP Features at a Glance**

When entered, SET-UP mode provides two brief summaries of the current feature status. The first presentation -- SET-UP A -- displays the location of the tab stops set in the terminal and a visual ruler which numbers each character position on the line. The second presentation -- SET-UP B -- summarizes the status of the other terminal features.

SET-UP A -- To enter SET-UP A, press the SET-UP key. The display will now have a presentation similar to Figure 1-4. The bottom line of the display consists of a "ruler" which numbers each character position available on a line. The location of each tab stop is shown by a "T" placed above the ruler. If the tab stop(s) set are those desired, you may exit SET-UP mode by pressing the SET-UP key again or you may now change the tabs to meet your requirements.

SET-UP B -- SET-UP B mode may only be entered from SET-UP A mode. To enter SET-UP B from SET-UP A, press the 5 key on the main keyboard. The display will then look like Figure 1-5.

Figure 1-6 summarizes the SET-UP B presentation. This summary allows you to quickly determine what features are enabled. For additional information on a feature refer to the Definition of Each Feature section.

To exit SET-UP B press the SET-UP key.

### **Determining What a SET-UP Feature Does**

The SET-UP features are basically a series of options in the VT100 that allow the terminal to be tailored to its operating environment. Table 1-1 lists each feature and places it in one or more of the following general categories:

- Installation
- Computer compatibility
- Operator comfort

The installation category concerns itself with the initial installation of the terminal and any special options that may be attached to the terminal. If any terminal options are added or removed, or the physical location of the installation is changed, verify the settings of these SET-UP features.

Computer compatibility contains the features which must be set correctly so that the VT100 can communicate with the host computer. An error in these settings may cause incorrect data to be sent to or received from the computer; or an error may prevent the VT100 from communicating with the computer. The settings for these features must be obtained from the host computer programmer, operator, or system manager since there are many combinations of settings designed to work with particular computers and special software. These feature settings would normally change only when you need to communicate with a different computer or a unique software package.

The operator comfort category contains the SET-UP features designed exclusively for the operator. These features allow the operator to tailor the VT100 to fit individual preference. These features do not affect any operations that occur between the terminal and the computer.

The next section, Definition of Each SET-UP Feature, describes the specific function of each feature.

### **How To Change a SET-UP Feature**

Changing any or all of the SET-UP features is a simple operation and is generally performed by following the same basic steps.



1. Enter SET-UP mode by pressing the SET-UP key
2. Select the appropriate SET-UP mode by pressing the 5 key on the main keyboard each time you want to switch from SET-UP A to SET-UP B or from SET-UP B to SET-UP A.
3. Position the cursor above the feature switch or tab stop to be changed. To position the cursor, the SPACEBAR, , , TAB and RETURN keys may be used. Some features do not use this step since a specific key is dedicated to changing the feature.
4. Change the feature setting by pressing either the 6 key on the main keyboard or the appropriate dedicated key. Each time the key is pressed the feature will change, generally to the opposite state.

Table 1-2 briefly summarizes the SET-UP features, the SET-UP mode you must be in to change a given feature, and the key used to change the feature setting.

### **Setting the Answerback Message**

Setting the answerback message is different from setting any of the other terminal features. An answerback message can be typed into the VT100, using the following steps:

1. Place the terminal in SET-UP B mode.
2. Press the SHIFT and A key simultaneously. The terminal will respond by placing A = on the screen. (The SHIFT key is required. The CAPS LOCK key will not work here.)
3. Type the message delimiter character which may be any character not used in the actual answerback message. The message delimiter character is not a part of the answerback message. If a mistake is made when typing the answerback message, type the message delimiter character again and go back to step 2. This is the only way to correct errors in the answerback message.
4. Type the answerback message. The message may be up to 20 characters, including space and control characters. Control characters will be displayed as a  character to indicate their presence in the message.
5. Type the message delimiter character. Once the message delimiter character is typed the answerback message will disappear from the screen.

Once the above steps have been completed the answerback message will be temporarily stored in the VT100 and can be saved with the Save operation.

### **Saving the SET-UP Features**

SET-UP features may be changed and stored on either a temporary or a fixed basis. To temporarily store a feature, exit SET-UP mode after changing the feature; the terminal now reacts according to the new setting. If a recall operation is performed, or the terminal is reset, or the terminal power is turned off, all temporary feature settings are replaced by the features that have been stored on a fixed basis.

To store SET-UP feature settings on a fixed basis, perform a save operation. This is a simple operation that is accomplished by performing the following steps:

1. Place the terminal in SET-UP mode.
2. Press the SHIFT and S keys simultaneously. The screen will clear and the message "wait" will be displayed in the upper-left corner. After a brief wait, the terminal will return to SET-UP A mode.

*NOTE: The save operation must be performed at the terminal keyboard. The computer cannot perform this operation, although it can temporarily modify the settings of some VT100 features.*

Once these steps have been performed, SET-UP features which had been temporarily stored will now be stored on a fixed basis.

### **Recalling SET-UP Features**

The temporarily stored SET-UP feature settings may differ from the settings which have been stored on a fixed basis. If you wish to return to the fixed settings, perform the recall operation as follows:

1. Place the terminal in SET-UP mode.
2. Press the SHIFT and R keys simultaneously. The screen will clear and the message "wait" will appear in the upper-left corner of the screen. After a brief wait the terminal will return to SET-UP A mode.

*NOTE: When a recall operation is performed the contents of the screen are destroyed.*

### **Resetting the Terminal**

The VT100 may be reset from the keyboard. When the terminal is reset, the terminal memory is cleared and the self-test program is run as if the terminal power switch had been turned OFF and then back ON. To reset the terminal:

1. Place the terminal in SET-UP mode.
2. Press the 0 key on the main keyboard. The VT100 will be reset, the power on self-test will be run, and the terminal will set according to the fixed SET-UP features.

*NOTE: When a reset operation is performed the contents of the screen are destroyed and any options present may be affected.*

### **Part 3 -- Definition of Each SET-UP Feature**

This section describes each SET-UP feature in detail (in alphabetical order) and states how each feature affects the terminal.

*NOTE: Unless otherwise stated, entering SET-UP mode and changing features does not result in the loss of data displayed on the screen.*

#### ANSI/VT52 Mode

The VT100 terminal follows two different programming standards -- American National Standards Institute (ANSI) and VT52. In ANSI mode, the VT100 will generate and respond to coded sequences per ANSI standards X3.41-1974 and X3.64-1977. In VT52 mode, the VT100 terminal is compatible with previous DIGITAL software using the VT52 video terminal. Both ANSI and VT52 modes are outlined in the programmer's section of this manual.

#### ANSWERBACK Message

Answerback is a question and answer sequence where the host computer asks the terminal to identify itself. The VT100 answerback features provides the terminal with the capability to identify itself by sending a message to the host. The entire answerback sequence takes place automatically without affecting the screen or requiring operator action. The answerback message may also be transmitted by typing CTRL-BREAK.

#### AUTO REPEAT

The auto repeat feature allows a key to be automatically repeated at the rate of about 30 characters per second when the key is held down for more than one-half second. The auto repeat feature affects all keyboard keys except the following:

- SET-UP
- ESC

- NO SCROLL
- TAB
- RETURN
- CTRL and any key

#### AUTO XON/XOFF

The VT100 is capable of automatically generating synchronizing codes XON (DC1) and XOFF (DC3). The XOFF code is used to stop the transmission of data from the computer to the terminal; the XON code is used to resume transmission. With the feature enabled, the VT100 will generate the XOFF code when one of the following events occur:

1. The internal buffer is nearly full
2. The NO SCROLL key is pressed
3. The terminal is placed in SET-UP mode
4. CTRL-S is pressed.

*NOTE: The VT100 will always stop transmission when an XOFF (DC3) code is received and will resume transmission when an XON (DC1) code is received regardless of the AUTO XON/XOFF feature setting.*

When either the buffer empties, the NO SCROLL key is pressed again, the terminal is taken out of SET-UP mode, or CTRL-Q is pressed, the VT100 will transmit the XON code to resume transmission from the computer to the terminal.

If the host computer software does not support the XON/XOFF codes, data sent during buffer full conditions, or when the terminal is in SET-UP mode, may be lost.

#### BITS PER CHARACTER

This feature allows the terminal to transmit and receive either 7- or 8-bit characters. When set for 8-bit operation, bit 8 is set to a space (or 0) for characters transmitted and is ignored for all characters received.

#### CHARACTERS PER LINE

The VT100 is capable of displaying either 80 or 132 characters per line. In the 80 character per line mode, the screen is 80 characters wide by 24 lines high. In the 132 character per line mode, the screen is 132 characters wide by 14 lines high (24 lines if the VT100 is equipped with the Advanced Video Option). In the 132 character per line mode, the displayed lines are physically the same width as in the 80 character per line mode but the characters are more compact.

*NOTE: When changing from 80 to 132 character per line mode or vice-versa, the current contents of the screen are lost.*

*The use of double-width characters reduces the number of characters per line by half.*

## CURSOR

The VT100 offers a choice of two cursor representations to indicate the "active position", or where the next character will be placed on the screen. The cursor may be displayed as either a blinking underline (    ) or a blinking block ( **█** ). The cursor selection may perform an additional function; see the SGR escape sequence definition in Chapter 3.

## INTERLACE

This feature is used for high resolution options. To reduce screen flicker the interlace feature should be turned off if such an option is not installed.

## KEYCLICK TONE

The keyclick is a tone which is generated every time a code transmitting key is pressed. The keyclick may be turned on or off to suit the operator's needs. However, research and experience has shown that an operator is more accurate when there is an audible feedback from the keyboard.

Like the bell tone, the keyclick volume is not adjustable.

## LINE/LOCAL

The LINE/LOCAL feature allows the operator to easily place the terminal in either an ON-LINE or a LOCAL (off-line) condition. When the terminal is on-line (the keyboard ON-LINE indicator is ON) all characters typed on the keyboard are sent directly to the computer and messages from the computer are displayed on the screen. In the LOCAL condition (the keyboard LOCAL indicator is ON), the terminal is electrically disconnected from the computer; messages are not sent to or received from the computer; and characters typed on the keyboard are echoed on the screen directly.

## MARGIN BELL

The margin bell feature is much the same as the bell in a typewriter. If the cursor is eight characters from the end of the current line while typing, the VT100 sounds a tone to alert the operator.

## NEW LINE

The new line feature enables the RETURN key on the terminal to function like the RETURN key on an electric typewriter. When the new line feature is enabled, pressing the RETURN key generates the carriage return (CR) and line feed (LF) codes. When a line feed code is received, the code is interpreted as a carriage return and line feed.

*NOTE: If double line feeds occur consistently, turn this feature off since the computer is already performing this function automatically.*

When the new line feature is disabled, the RETURN key generates only the CR code; an LF code causes the terminal to perform a line feed only.

#### PARITY

Parity, when enabled, checks for correct data transmission. If a transmission error occurs, the VT100 can detect it and indicate its presence by placing a checkerboard character (⌘) on the screen in place of the character with the error. The parity sense feature determines if the parity is even or odd. When parity is disabled, no parity bit is transmitted or received.

*NOTE: If the parity feature is turned off, the parity sense selection will be disregarded.*

#### PARITY SENSE

The parity sense feature defines which of the two methods of parity checking, odd or even, is being used by the VT100. If the parity feature is on, the terminal's parity sense must be matched to the parity the computer is sending. If the parity sense features do not match, most characters sent to the computer will be rejected even though the character was received correctly by the VT100. If a parity incompatibility occurs, the checkerboard character (⌘) will be shown on the screen in place of the received character.

#### POWER

During the initial installation, the terminal display must be set to the power line frequency. In the U.S. this is set to 60 hertz.

#### RECEIVE SPEED

The receive speed must be set to match the computer transmit speed. The VT100 is capable of receiving at any one of the following preselected speeds: 50, 75, 110, 134.5, 150, 200, 300, 600, 1200, 1800, 2000, 2400, 3600, 4800, 9600, 19,200 baud.

#### SCREEN BACKGROUND

The screen background feature of the VT100 allows the operator to determine the background of the screen. In the normal screen mode, the display contains light characters on a dark background; in the reverse screen mode, the display contains dark characters on a light background.

#### SCREEN BRIGHTNESS

Unlike most video terminals, the VT100 does not contain switches or knobs to adjust screen brightness. Instead, the VT100 electronically controls the screen brightness. This feature eliminates the high failure rate of mechanical controls and still allows the operator to select the desired level of brightness for maximum comfort under varied lighting conditions. This setting may be saved like any other feature in the terminal.

## SCROLL

Scrolling the upward or downward movement of existing lines on the screen to make room for new lines at the bottom or top of the screen. It can be performed in two ways: jump scroll or smooth scroll. In jump scroll mode, new lines appear on the screen as fast as the computer sends them to the terminal. At the higher baud rates, the data is very difficult to read due to the rapid movement of the lines. In smooth scroll mode, a limit is placed on the speed at which new lines of data may be sent to the terminal. The movement of lines occurs at a smooth steady rate allowing the data to be read as it appears on the screen.

*NOTE: Smooth scroll mode allows a maximum of six lines of data per second to be added to the screen. The Auto XON/XOFF feature must be enabled and supported by the host computer to ensure that data is not lost when smooth scroll mode is enabled.*

## TABS

Just like a typewriter, the VT100 can jump or tab to preselected points on a line. These tab stops may be individually changed, or totally cleared and then set.

## TRANSMIT SPEED

Transmit speed must be set to match the computer receive speed. The VT100 is capable of transmitting at any one of the following preselected transmit speeds: 50, 75, 110, 134.5, 150, 200, 300, 600, 1200, 1800, 2000, 2400, 3600, 4800, 9600, and 19,200 baud.

Transmit speed is independent of receive speed; the terminal may transmit data at one speed and receive data at a different speed.

## WRAPAROUND

When this feature is enabled, the 81st or 133rd character (depending upon the line size selected) inserted on a line is automatically placed in the first character position of the next line. If the wraparound feature was not enabled, the 81st or 133rd character and all following characters would be overwritten into the last character position of the current line.

*NOTE: The use of double-width characters reduces the number of characters per line by half.*

# £
3

 (shifted)

The VT100 contains character sets for the U.S. and the United Kingdom. The difference between the two character sets is one character, the # or £ symbol. When the standard U.S. character set is selected, the uppercase 3 key on the main keyboard displays the # character. The £ character is displayed when the U.K. character set is selected.

## Part 4 -- Self-Testing the VT100

A self-test mode is built into the VT100 that automatically, or on command, tests the condition of the terminal should a fault be suspected. The self-test program checks the following items:

- Advanced Video Memory (if option is installed)
- Nonvolatile Memory (NVR)
- Internal Memory
- Keyboard

This test is performed automatically whenever the terminal is turned on.

### Self-Test Error Codes

There are two broad categories of errors: fatal and nonfatal.

Fatal errors cause the terminal to immediately stop all operations. No intelligible information is displayed on the screen; however, the screen most likely contains a random pattern of characters. The only error indication (in addition to the random characters) is a possible error code displayed on the programmable keyboard LEDs, L1--L4; however, no terminal function, including the lighting of LEDs, is guaranteed if a fatal error is found.

*NOTE: The loopback and EIA modem control tests are not performed on power-up; they must be invoked separately with the proper escape sequence. See the programmer's section for further information on these tests.*

Nonfatal errors do not halt the terminal processor. Instead, the terminal is forced to LOCAL mode and an error code character is displayed in the upper-left corner of the screen.

There are five types of nonfatal errors:

1. (AVO) Advanced Video Option data RAM
2. (NVR) Nonvolatile data RAM checksum error
3. (KBD) Keyboard missing or malfunction
4. (Data) Data loopback error
5. (EIA) EIA modem control error

Table 1-3 shows the possible nonfatal error characters that may appear on the screen and the failure represented by each character.

## Part 5 -- What To Do in the Event of a Problem

If it appears that there is a problem in the terminal, you should initiate the power-up self-test program. This test will help to determine if the problem lies in your terminal or in some other part of the computer system. Table 1-4 describes the items an operator can check prior to making a service call.

# Chapter 2

## Installation, Interface Information and Specifications

### Installation

#### Site Considerations

The design of the VT100 terminal (Figure 2-1) will normally pose few constraints on selecting a place in which to install the terminal. In most cases, any environment suitable to the terminal operator will be a satisfactory environment in which to operate the terminal. Extremes of temperature and humidity should be avoided. A summary of VT100 guaranteed operating conditions is found at the end of this section.

#### Unpacking and Maintenance

The VT100 shipping carton contains the following items:

- VT100 monitor
- VT100 detached keyboard
- VT100 power cord
- VT100 SET-UP label
- VT100 User's Guide

To install the VT100 perform the following steps:

1. Remove the VT100 from the shipping carton and place it in the desired work area.
2. Place the keyboard in front of the terminal and plug the keyboard coiled cord into the keyboard receptacle located on the rear of the terminal (Figure 2-2).
3. Verify that the power selector switch shows the correct wall outlet voltage (115 V is standard in the U.S.) and the power switch is off.
4. Connect the power cord to the power cord receptacle on the rear of the terminal and plug the other end of the power cord into a nearby wall outlet.

5. Connect the communications cable to the appropriate communications receptacle.
6. Turn the power switch on. The terminal will now automatically perform the power-up self-test and either the ON LINE or LOCAL light located on the keyboard will be turned on. After approximately one minute the cursor will be visible in the upper-left corner of the screen. If any other indication is shown, refer to Part 5 of the operator information chapter.
7. Set the desired SET-UP features as outlined in the operator's section of this manual.
8. Once the installation setup procedure is complete, record the SET-UP features selected on the VT100 SET-UP label and attach the label to the underside of the keyboard.

## **User Maintenance**

The keyboard keys are the only moving parts of the terminal and require no preventive maintenance by the owner. The VT100 surfaces may be cleaned with soap and water or any mild detergent. Cleaners with solvents should not be used.

The VT100 packaging is not meant to be weatherproof; there are several openings in the case through which liquids, coins, paper clips, and other objects can fall. Such objects would disturb the electronic operation of the terminal if they came into contact with the circuitry. For this reason, avoid putting drinks and metal objects on the top of the terminal, or using excessive water to clean the terminal. Rubbing the keys with a dry or barely moist cloth should suffice to clean them. Do not remove the keycaps to clean them more thoroughly; damage may result to the switch contacts if they are replaced incorrectly.

Keep the ventilation slots clear. Blocking these slots by placing objects on top of or under the VT100 may cause the terminal to overheat.

## **Interface Information**

### **EIA Interface**

The basic VT100 operates on full duplex, asynchronous communication lines. The terminal interfaces to the line with a 25-pin connector mounted on the back of the terminal which meets the requirements of EIA specification RS-232-C. Table 2-1 summarizes the EIA connector signals; the following paragraphs explain each signal as used in the basic VT100.

Protective Ground -- Pin 1

This conductor is electrically bonded to the VT100 chassis. Use of this conductor for reference potential purposes is not allowed.

Transmitted Data (from VT100) -- Pin 2

The VT100 transmits serially encoded characters and break signals on this circuit, which is held in the mark state when neither characters nor break signals are being transmitted.

Received Data (to VT100) -- Pin 3

The VT100 receives serially encoded characters generated by the user's equipment on this circuit.

Request to Send (from VT100) -- Pin 4

Asserted at all times when terminal is powered up.

Clear to Send (to VT100) -- Pin 5

Ignored at all times.

Data Set Ready (to VT100) -- Pin 6

Ignored at all times.

Signal Ground -- Pin 7

This conductor establishes the common ground reference potential for all voltages on the interface. It is permanently connected to the VT100 chassis.

Carrier Detect (to VT100) -- Pin 8

Ignored at all times.

Speed Select (from VT100) -- Pins 11, 19, and 23

This signal is alternately called Secondary Request to Send. The basic VT100 maintains this line in the asserted state at all times.

Speed Indicator (to VT100) -- Pin 12

This signal, alternately called Secondary Carrier Detect, is ignored at all times.

Transmission Clock (to VT100) -- Pin 15

Ignored at all times.

Receive Clock (to VT100) -- Pin 17

Ignored at all times.

Data Terminal Ready (from VT100) -- Pin 20

Data Terminal Ready is asserted at all times except under the following conditions:

1. Terminal is not powered up
2. Terminal is in LOCAL mode
3. The 3.5 second interval following the pressing of SHIFT-BREAK.

Ring Indicator (to VT100) -- Pin 22

Ignored at all times.

### **Electrical Characteristics**

VT100 Output Voltages -- On signals designated "from VT100", the mark, or unasserted state, is -6.0 V to -

12.0 V; the space, or asserted state, is +6.0 V to +12.0 V.

VT100 Input Voltages -- On signals designated "to VT100", -25.0 V to +0.75 V or an open circuit is interpreted as a mark or unasserted state, and +25.0 V to +2.25 V is interpreted as a space or asserted state. Voltages greater in magnitude than  $\pm 25$  V are not allowed. These levels are compatible with EIA STD RS-232-C and CCITT Recommendation V.28.

### **Optional 20 mA Current Loop Interface**

In most current loop applications, the VT100 will be connected in a passive configuration -- that is, current is supplied to the VT100. In this mode, the transmitter and receiver are both passive, both optically isolated, and the transmitter goes to the mark state when power is turned off.

Conversion from active to passive (or vice versa) requires moving a slide switch.

In active mode either the transmitter or the receiver or both may be connected so that the VT100 sources the 20 mA of current. In active mode isolation is not present and the transmitter will go to the space state when power to the VT100 is turned off.

Figure 2-3 shows the 20 mA current loop interface connector mounted to the access cover and the individual pin assignment.

#### **Electrical Characteristics**

The electrical characteristics of the 20 mA current loop interface are shown below:

	Transmitter		Receiver	
	Min	Max	Min	Max
Open circuit voltage	5.0 V	50 V	Voltage drop marking	-- 2.5 V
Voltage drop marking	--	4.0 V	Spacing current	-- 3.0 mA
Spacing current	--	2.0 mA	Marking current	15 mA 50 mA
Marking current	20 mA	50 mA		

In addition to the above specifications for passive operation, active mode will place the transmitter or receiver in series with a source of 17 V  $\pm 5$  percent and 660 ohms.

### **External Video Connections**

In addition to the EIA interface, the VT100 is also capable of easily interfacing to external video devices.

The video devices may act either as a slave to the VT100 when connected to the composite video output or provide synchronized video to the VT100 video section when connected to the video input. The external video connectors are the two female BNC connectors located on the back of the terminal just below the EIA connector. The upper connector, J8, is the video input while the lower connector, J9, is the video output.

#### Composite Video Output (J9)

The composite video output provides RS170-like output (see note) generated by combining the video signal with a composite sync signal. This output contains all video data appearing on the VT100 screen except that video which comes from J8. The output has the following nominal characteristics. (Refer to Figure 2-4).

1. Output impedance = 75 ohms, dc-coupled
2. Sync level = 0 V
3. Black level = approximately 0.3 V when loaded with 75 ohms
4. White level = approximately 1.0 V with a 75 ohm load
5. The composite sync waveform conforms to EIA RS170 standards. The vertical interval is composed of six equalizing pulses, six vertical sync pulses, and six more equalizing pulses. The timing is as follows:

Equalizing pulse width	= 2.33 $\mu$ s $\pm$ 50ns
Vertical pulse width	= 27.28 $\mu$ s $\pm$ 200ns
Horizontal pulse width	= 4.71 $\mu$ s $\pm$ 50ns
Horizontal blank width	= 11.84 $\mu$ s $\pm$ 50ns/80 column mode = 12.34 $\mu$ s $\pm$ 50ns/132 column mode
Front porch	= 1.54 $\mu$ s $\pm$ 50ns

*NOTE: The use of dc-coupling is not in strict agreement with RS170. To agree with RS170 the output load requires a 10 $\mu$ F capacitor in series with the output. Failing to do so, the 2 mA dc short circuit current requirement is violated. This presents no problem with most monitors which are in fact ac-coupled.*

#### Video Input (J8)

An analog signal applied to the video input will be "ORed" with the internal video signal in such a way that the beam intensity at any point on the screen will correspond to the intensity of that signal which would tend to make the beam brighter at that point. A video signal on this input affects only the internal screen and

does not appear on the composite video output. This input has the following nominal characteristics.

1. Input impedance = 75 ohms, dc-coupled
2. Black level = 0 V
3. White level = 1.0 V
4. Maximum continuous input =  $\pm 2.0$  V

The external video source must be synchronized to the VT100; it may do this by referencing the composite sync on the composite video output. This means that the VT100 video input will not synchronize with any composite video source including the composite video output of another VT100.

### **VT100 Specifications**

#### Dimensions

Monitor	Height: 36.83 cm (14.5 inch) Width: 45.72 cm (18 inch) Depth: 36.20 cm (14.25 inch)
Keyboard	Height: 8.89 cm (3.5 inch) Width: 45.72 cm (18 inch) Depth: 20.32 cm (8 inch) Minimum table depth: 51.4 cm (20.25 inch)

#### Weight

Monitor	13.6 kg (30 lbs)
Keyboard	2.0 kg (4.5 lbs)
Shipping Weight	18.6 kg (41 lbs)

#### Environment

Operating	Temperature: 10° to 40° C (50° to 104° F) Relative humidity: 10% to 90% Maximum wet bulb: 28° C (82° F) Minimum dew point: 2° C (36° F) Altitude: 2.4 km (8,000 ft)
Non-Operating	Temperature: -40° to 66° C (-40° to 151° F) Relative humidity: 0 to 95% Altitude: 9.1 km (30,000 ft)

#### Power

Line Voltage	90-128 V RMS single phase, 2 wire 180-256 V RMS single phase, 2 wire (switch-selectable)
--------------	--

Line Frequency 47-63 Hz

Current 2.2 A RMS maximum at 115 V RMS  
1.1 A RMS maximum at 230 V RMS

Input Power 250 VA apparent 150 W maximum

Current 3 A normal blow fuse  
limiting

Power cord detachable, 3 prong, 1.9 m (6 ft)

#### Display

CRT 12 inch diagonal measure, P4 phosphor

Format 24 lines × 80 characters or 14 lines × 132  
characters (selectable)

Character 7 × 9 dot matrix with descenders

Character 3.35 mm × 2.0 mm (0.132 inch × 0.078 inch)  
size in 80 column mode  
3.35 mm × 1.3 mm (0.132 inch × 0.051 inch)  
in 132 column mode

Active 202 mm × 115 mm (8 inch × 4.5 inch)  
Display Size

Character Set 96 character displayable ASCII subset  
(upper- and lowercase, numeric and  
punctuation)

Cursor type Keyboard-selectable, blinking block  
character or blinking underline

#### Keyboard

General 83-key detachable unit with a 1.9 m (6 ft)  
coiled cord attached

Key Layout 65-key arrangement and sculpturing similar  
to standard typewriter keyboard with an 18-  
key auxiliary keypad.

Auxiliary 18-key numeric pad with period, comma,  
Keyboard minus, enter, and four general-purpose  
function keys

Visual Seven LEDs; three LEDs dedicated to ON LINE,  
Indicators LOCAL and KBD LOCKED, four LEDs user-  
programmable.

Audible Key-click: sound simulates typewriter.  
Signals Bell:

1. sounds upon receipt of BEL code;
2. sounds eight characters from right  
margin (keyboard-selectable)

Multiple bell: sounds upon detection of error in SET-UP save or recall operation.

#### Communication

Type	EIA
Speeds	Full duplex: 50, 75, 110 (two stop bits), 134.5, 150, 200, 300, 600, 1200, 1800, 2000, 2400, 3600, 4800, 9600, 19,200
Code	ASCII
Character Format	Asynchronous
Character Size	7 or 8 bits; keyboard-selectable. (Note: if 8-bit character is selected, eighth bits is always space).
Parity	Even, odd, or none -- keyboard-selectable
Synchronization	Keyboard-selectable via automatic generation of XON and XOFF control codes.

#### **How to Order Hardware Documentation**

The following VT100 Video Terminal hardware manuals can be purchased from DIGITAL's Accessory and Supplies Group.

Part No.	Title
EK-VT100-UG	VT100 User Guide
EK-VT100-J1	VT100 Mini Maintenance Manual
EK-VT100-TM	VT100 Technical Manual
EK-VT100-IP	VT100 Illustrated Parts Breakdown (IPB)
MP-00633	VT100 Print Set

All purchase orders for hardware manuals should be forwarded to:

Digital Equipment Corporation  
Cotton Road  
Nashua, N.H. 03060

Supplies and Accessories Group (P086)

Purchase orders must show shipping and billing addresses and state whether a partial shipment will be accepted.

All correspondence and invoicing inquiries should be directed to the above address.

# Chapter 3

## Programmer Information

The VT100 terminal normally performs a two-part function. It is an input device to a computer -- information entered through the keyboard is sent to the computer. It is simultaneously an output device for the computer -- that is, data coming in from the computer is displayed on the video screen. [Figure 3-1](#) shows the data flow.

This section of the user's manual discusses data flow between the VT100 and the host. Included are codes generated by the keyboard; the transmission protocol followed by the terminal; and the actions and reactions of the terminal to control functions in both ANSI and VT52 modes of operation.

### The Keyboard

The VT100 uses a keyboard with a key arrangement similar to an ordinary office typewriter, as shown in [Figure 3-2](#). In addition to the standard typewriter keys the VT100 keyboard has additional keys and indicators used to generate control sequences, cursor control commands, and to show the current terminal status.

#### LED Indicators

The keyboard has seven light emitting diodes (LEDs) of which two are committed to the complementary ON-LINE/LOCAL function. The power on condition is implicitly shown by one of the two LEDs being on; that is, if the keyboard is connected and power is on, one of these LEDs will be on.

A third LED indicates a "keyboard locked" condition. In this condition the keyboard has been "turned off" automatically by the terminal due to a full buffer or by the host through the transmission of an XOFF to the terminal.

The four remaining LEDs are programmable and can be assigned any meaning for specific applications. The code sequences to turn these LEDs on or off are discussed later in this chapter.

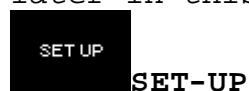

The **SET-UP** key is at the upper-left corner of the main

key array. Operations performed in SET-UP mode can be stored in nonvolatile memory (NVR) so that turning the terminal power off does not, by itself, alter the terminal configuration.

The procedures to change the SET-UP features are provided in the operator's information section of this manual. Those SET-UP features which may be modified by the host are listed in [Table 3-1](#) and described in detail under the escape sequences.

### **Keyboard Operation**

The operator uses the keyboard to transmit codes to the host. Some keys transmit one or more codes to the host immediately when typed. Other keys such as **CTRL** and **SHIFT** do not transmit codes when typed, but modify the codes transmitted by other keys. The code-transmitting keys cause the terminal to make a clicking sound to verify to the operator that the keystroke has been processed by the terminal. If two code-transmitting keys are pressed together, two codes will be transmitted according to the order in which the keys were typed. The terminal will not wait for the keys to be lifted, but will transmit both codes as soon as possible after the keys are first typed. If three such keys are pressed simultaneously, the codes for the first two keys are transmitted immediately; the code for the third will be transmitted when one of the first two keys is lifted.

**Alphabetic Keys** -- The VT100 will transmit the lowercase code unless either or both of the **SHIFT** keys are down, or unless the **CAPS LOCK** key is down. Pressing the **CAPS LOCK** key will lock only the 26 alphabetic keys in the shifted (uppercase) mode. [Table 3-2](#) shows the codes generated by the alphabetic keys.

**Nonalphabetic Keys** -- Each of the nonalphabetic keys can be used to generate two different codes. One code will be generated if neither **SHIFT** key is pressed. The other code will be generated if either or both of the **SHIFT** keys are down. Unlike the **SHIFT LOCK** key of a typewriter, the **CAPS LOCK** key does not affect these keys; it affects only the alphabetic keys. [Table 3-3](#) shows the nonalphabetic keys and the codes they generate.

**Function Keys** -- There are several keys on the keyboard which transmit control codes. Control codes do not produce displayable characters but are codes for functions. If these codes are received by the terminal, the VT100 will perform the associated function as shown in [Table 3-4](#).

**NO SCROLL** -- When the **NO SCROLL** key is pressed it generates a single XOFF code, inhibits further scrolling and freezes the screen. When pressed again the same key generates XON. In practice, if the software recognizes XOFF, the host will stop transmitting until the **NO SCROLL**

key is pressed again to allow scrolling. If the XOFF/XON feature is disabled (SET-UP function) the **NO SCROLL** key causes no action.

**BREAK** -- Typing the **BREAK** key causes the transmission line to be forced to its zero state for 0.2333 seconds  $\pm$  10 percent. If either **SHIFT** key is down, the time is increased to 3.5 seconds  $\pm$  10 percent. Data Terminal Ready is also deasserted during this interval. At the conclusion of the 3.5 second interval Data Terminal Ready will again be asserted.

The **SHIFT** and **BREAK** keys typed together provide the long-break-disconnect function. Used with properly configured modems with RS-232-C levels, it will cause both the local and remote data sets to disconnect. For modems that are connected via the 20 mA current loop, issuing the long space may disconnect the remote data set only.

The **CTRL** and **BREAK** keys typed together cause the transmission of the answerback message.

The **BREAK** key does not function when the VT100 is in LOCAL mode.

**Auto Repeating** -- All keys will auto repeat except: **SET-UP**, **ESC**, **NO SCROLL**, **TAB**, **RETURN**, and any key pressed with **CTRL**. Auto repeating works as follows: when a key is typed, its code(s) is sent once, immediately. If the key is held down for more than  $\frac{1}{2}$  second, the code(s) will be sent repeatedly at a rate of approximately 30 Hz (less if low transmit baud rates are used) until the key is released.

**CTRL (Control)** -- The **CTRL** key is used in conjunction with other keys on the keyboard to generate control codes. If the **CTRL** key is held down when any of the keys in [Table 3-5](#) are typed, the code actually transmitted is in the range  $000_8-037_8$ .

**Cursor Control** -- The keyboard also contains four keys labeled with arrows in each of four directions. These keys transmit control sequences. If the host echoes these control sequences back to the terminal, the cursor will move one character up, down, right, or left. [Table 3-6](#) shows the control sequences generated by each key.

**Auxiliary Keypad** -- The keys on the auxiliary keypad normally transmit the codes for the numerals, decimal point, minus sign, and comma. In addition, the key labeled **ENTER** transmits the same code as the **RETURN** key. The host cannot tell if these keys were typed on the auxiliary keypad as opposed to the corresponding keys on the main keyboard. Therefore, software which requires considerable numeric data entry need not be rewritten to use the keypad.

However, if software must be able to distinguish between pressing a key on the auxiliary keypad and pressing the corresponding key on the main keyboard, the host can give

the terminal a command to place it in keypad application mode. In keypad application mode all keys on the auxiliary keypad are defined to give control sequences which may be used by the host as user-defined functions. The codes sent by the auxiliary keypad for the four combinations of the VT52/ANSI mode and keypad numeric/application mode are shown in Tables 3-7 and 3-8. None of the keys are affected by pressing the **SHIFT**, **CAPS LOCK**, or **CTRL** keys.

### **Special Graphics Characters**

If the Special Graphics set is selected, the graphics for ASCII codes 137<sub>8</sub> through 176<sub>8</sub> will be replaced according to Table 3-9. (See the SCS control sequence).

## **Communications Protocols**

### **Full Duplex**

The terminal can operate at transmission speeds up to 19,200 baud. However, the terminal may not be able to keep up with incoming data. The terminal stores incoming characters in a 64-character buffer and processes them on a first-in/first-out basis. When the content of the buffer reaches 32 characters, the terminal will transmit 023<sub>8</sub> (XOFF or DC3). On this signal the host should suspend its transmission to the terminal. Eventually, if the host stops transmitting, the terminal will deplete the buffer. When 16 characters remain in the buffer the terminal will transmit 021<sub>8</sub> (XON or DC1) to signal the host that it may resume transmission.

If the host fails to respond to an XOFF from the terminal in a timely manner, the buffer will continue to fill. When the 64-character capacity of the buffer is exceeded, a condition occurs called "buffer overflow". To determine if the buffer will overflow use the following formulas:

$$\text{No. of characters to overflow} = 32 - [3 \times (\text{receiver speed} / \text{transmit speed})]$$

$$\text{Time to respond to XOFF} = \text{No. of characters to overflow} \times (\text{bits per character} + \text{parity bit} + 2) / \text{receiver speed}$$

#### **Example 1:**

The VT100 is transmitting 8-bit characters with no parity at 1200 baud and receiving at 1200 baud. The terminal has just sent an XOFF which the host must respond to with 0.2416 second to avoid a buffer overflow.

$$\text{No. of characters to overflow} = 32 - [3 \times (1200 / 1200)] = 29 \text{ characters}$$

$$\begin{aligned} \text{Time to respond to XOFF} &= 29 \times [8 + 0 + 2] / 1200 = \\ &0.2416 \text{ second} \end{aligned}$$

**Example 2:**

The VT100 is transmitting 7-bit characters with parity at 300 baud and receiving at 1200 baud. The terminal has just sent an XOFF which the host must respond to within 0.1666 second to avoid a buffer overflow.

$$\begin{aligned} \text{No. of characters to overflow} &= 32 - [3 \times (1200 / 300)] = \\ &20 \text{ characters} \end{aligned}$$

$$\begin{aligned} \text{Time to respond to XOFF} &= 20 \times [7 + 1 + 2] / 1200 = \\ &0.1666 \text{ second} \end{aligned}$$

If the buffer overflows, the VT100 will begin to discard incoming characters and the error character will be displayed.

Software which does not support receipt of the XOFF/XON signals from the terminal can still use the VT100 provided the software never sends the ESC code to the terminal, the baud rate is limited to 4800 or less, and the software does not use smooth scrolling or split screen features.

Alternatively, if XOFF/XON cannot be used, fill characters may be used after characters or character strings are sent to the VT100. A reference chart of fill characters required for these functions is included in Appendix C.

Two of the terminal functions, Reset and Self-Test, reinitialize the terminal and erase the buffer. This means that if characters are received subsequent to the commands to perform these two functions and the characters are placed in the buffer, the character would be destroyed without being processed.

To compensate for this, the host may act in one of two ways:

1. Immediately after sending the terminal the commands to perform either the Reset or Self-Test functions, the host may act as if it had received XOFF from the terminal, thus sending no more characters until it receives XON. The terminal will transmit XON only after it completes the specified operation and the XOFF/XON feature is enabled.
2. When the first method cannot be implemented, a delay of no less than 10 seconds may be used to allow the terminal time to complete the invoked function. This method, however, does not guarantee against the loss of data when an invoked function has detected an error; and while this delay is currently adequate, future options may require a change in the time delay.

The XOFF/XON synchronization scheme has an advantage over requiring the host to insert delays or filler characters in its data stream. Requiring a minimum of software support, XON/XOFF ensures that every character or command sent to the VT100 will be processed in correct order. It frees interface programs from all timing considerations and results in more reliable operation.

In addition to the buffer-filling condition, there are two other means of transmitting XOFF and XON; the **NO SCROLL** key, and Control S/Control Q. If the XON/XOFF feature is enabled, the VT100 will coordinate these three sources of XOFF and XON so that the desired effect occurs. For example, if the buffer-filling condition has caused an XOFF to be sent, and then the operator types the **NO SCROLL** key, a second XOFF is not sent. Instead of sending an XON when the buffer empties, the VT100 waits until the operator types the **NO SCROLL** key again before sending XON.

Also, entering SET-UP mode causes the VT100 to temporarily stop taking characters from the buffer. An XOFF will be sent if the buffer becomes nearly full. Use of Control S and Control Q will also be synchronized with the **NO SCROLL** key.

If the XON/XOFF feature is disabled, the buffer-filling condition will not send an XOFF, the **NO SCROLL** key is disabled, and Control S and Control Q will be transmitted as typed.

The VT100 also recognizes received XOFF and XON. Receipt of XOFF will inhibit the VT100 from transmitting any codes except XOFF and XON. From three to seven keystrokes on the keyboard will be stored in a keyboard buffer (some keys transmit two or three codes, e.g., cursor controls). If the keyboard buffer overflows, keyclicks will stop and the KBD LOCKED LED will come on. Transmission resumes upon receipt of XON.

If the user transmits an XOFF to the host (by Control S or **NO SCROLL**), the host should not echo any further type-in until the user types XON. This places the burden of not overloading the host's output buffer on the user. Entering and exiting SET-UP clears the keyboard locked condition.

### **Terminal Control Commands**

The VT100 has many control commands which cause it to take action other than displaying a character on the screen. In this way, the host can command the terminal to move the cursor, change modes, ring the bell, etc. The following paragraphs discuss the terminal control commands.

## Control Characters

Control characters have values of  $000_8$  -  $037_8$ , and  $177_8$ . The control characters recognized by the VT100 are shown in [Table 3-10](#). All other control codes cause no action to be taken.

Control characters (codes  $0_8$  to  $37_8$  inclusive) are specifically excluded from the control sequence syntax, but may be embedded within a control sequence. Embedded control characters are executed as soon as they are encountered by the VT100. The processing of the control sequence then continues with the next character received. The exceptions are: if the character **ESC** occurs, the current control sequence is aborted, and a new one commences beginning with the **ESC** just received. If the character CAN ( $30_8$ ) or the character SUB ( $32_8$ ) occurs, the current control sequence is aborted. The ability to embed control characters allows the synchronization characters XON and XOFF to be interpreted properly without affecting the control sequence.

## Control Sequences

The VT100 is an upward and downward software compatible terminal; that is, previous DIGITAL video terminals have DIGITAL private standards for control sequences. The American National Standards Institute (ANSI) has since standardized escape and control sequences in terminals in documents X3.41-1974 and X3.64-1977.

*NOTE: The ANSI standards allow the manufacturer flexibility in implementing each function. This manual describes how the VT100 will respond to the implemented ANSI control function.*

The VT100 is compatible with both the previous DIGITAL standard and ANSI standards. Customers may use existing DIGITAL software designed around the VT52 or new VT100 software. The VT100 has a "VT52 compatible" mode in which the VT100 responds to control sequences like a VT52. In this mode, most of the new VT100 features cannot be used. Throughout this section of the manual, references will be made to "VT52 mode" or "ANSI mode". These two terms are used to indicate the VT100's software compatibility. All new software should be designed around the VT100 "ANSI mode". Future DIGITAL video terminals will not necessarily be committed to VT52 compatibility.

*NOTE: ANSI standards may be obtained by writing:*

*Sales Department*

*American National Standards Institute*

*1430 Broadway*

*New York, New York 10018*

## Valid ANSI Mode Control Sequences

### Definitions

The following listing defines the basic elements of the ANSI mode control sequences. A more complete listing appears in Appendix A.

Control Sequence Introducer (CSI)

An escape sequence that provides supplementary controls and is itself a prefix affecting the interpretation of a limited number of contiguous characters. In the VT100 the CSI is **ESC [**.

Parameter

1. A string of zero or more decimal characters which represent a single value. Leading zeroes are ignored. The decimal characters have a range of 0 (60<sub>8</sub>) to 9 (71<sub>8</sub>).
2. The value so represented.

Numeric Parameter

A parameter that represents a number, designated by Pn.

Selective Parameter

A parameter that selects a subfunction from a specified list of subfunctions, designated by Ps. In general, a control sequence with more than one selective parameter causes the same effect as several control sequences, each with one selective parameter, e.g., CSI Psa; Psb; Psc F is identical to CSI Psa F CSI Psb F CSI Psc F.

Parameter String

A string of parameters separated by a semicolon (73<sub>8</sub>).

Default

A function-dependent value that is assumed when no explicit value, or a value of 0, is specified.

Final character

A character whose bit combination terminates an escape or control sequence.

**Examples:**

1. Control sequence for double-width line (DECDWL) **ESC # 6**

**Sequence**

**Octal Representation of  
Sequence**

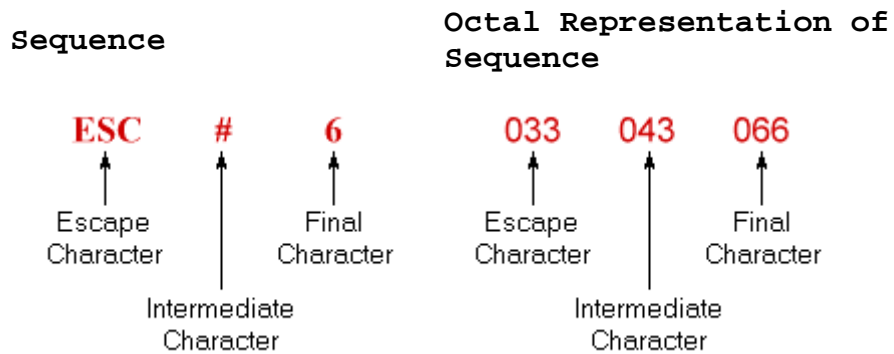

2. Control sequence to turn off all character attributes, and then turn on underscore and blink attributes (SGR). `ESC [ 0 ; 4 ; 5 m`

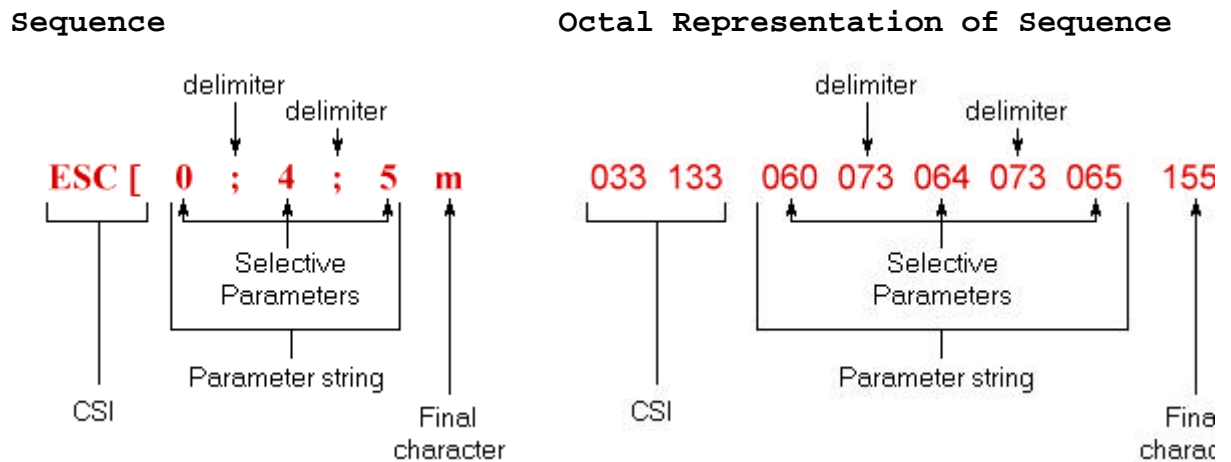

Alternative sequences which will accomplish the same thing:

Sequence	Octal Representation of Sequence
a. <code>ESC [ ; 4 ; 5 m</code>	<code>033 133 073 064 073 065 155</code>
b. <code>ESC [ m</code>	<code>033 133 155</code>
<code>ESC [ 4 m</code>	<code>033 133 064 155</code>
<code>ESC [ 5 m</code>	<code>033 133 065 155</code>
c. <code>ESC [ 0 ; 04 ; 005 m</code>	<code>033 133 060 073 060 064 073 060 060 065 155</code>

### Control Sequences

All of the following escape and control sequences are transmitted from the host computer to the VT100 unless otherwise noted. All of the control sequences are a subset of those specified in ANSI X3.64-1977 and ANSI X3.41-1974.

**CPR -- Cursor Position Report -- VT100 to Host**

**ESC [ Pn ; Pn R** *default value: 1*

The CPR sequence reports the active position by means of the parameters. This sequence has two parameter values, the first specifying the line and the second specifying the column. The default condition with no parameters present, or parameters of 0, is equivalent to a cursor at home position.

The numbering of lines depends on the state of the Origin Mode (DECOM).

This control sequence is solicited by a device status report (DSR) sent from the host.

**CUB -- Cursor Backward -- Host to VT100 and VT100 to Host**

**ESC [ Pn D** *default value: 1*

The CUB sequence moves the active position to the left. The distance moved is determined by the parameter. If the parameter value is zero or one, the active position is moved one position to the left. If the parameter value is n, the active position is moved n positions to the left. If an attempt is made to move the cursor to the left of the left margin, the cursor stops at the left margin.

*Editor Function*

**CUD -- Cursor Down -- Host to VT100 and VT100 to Host**

**ESC [ Pn B** *default value: 1*

The CUD sequence moves the active position downward without altering the column position. The number of lines moved is determined by the parameter. If the parameter value is zero or one, the active position is moved one line downward. If the parameter value is n, the active position is moved n lines downward. In an attempt is made to move the cursor below the bottom margin, the cursor stops at the bottom margin. *Editor Function*

**CUF -- Cursor Forward -- Host to VT100 and VT100 to Host**

**ESC [ Pn C** *default value: 1*

The CUF sequence moves the active position to the right. The distance moved is determined by the parameter. A parameter value of zero or one moves the active position one position to the right. A parameter value of n moves the active position n positions to the right. If an attempt is made to move the cursor to the right of the right margin, the cursor stops at the right margin.

*Editor Function*

**CUP -- Cursor Position**

**ESC [ Pn ; Pn H** default value: 1

The CUP sequence moves the active position to the position specified by the parameters. This sequence has two parameter values, the first specifying the line position and the second specifying the column position. A parameter value of zero or one for the first or second parameter moves the active position to the first line or column in the display, respectively. The default condition with no parameters present is equivalent to a cursor to home action. In the VT100, this control behaves identically with its format effector counterpart, HVP.  
*Editor Function*

The numbering of lines depends on the state of the Origin Mode (DECOM).

**CUU -- Cursor Up -- Host to VT100 and VT100 to Host**

**ESC [ Pn A** default value: 1

Moves the active position upward without altering the column position. The number of lines moved is determined by the parameter. A parameter value of zero or one moves the active position one line upward. A parameter value of n moves the active position n lines upward. If an attempt is made to move the cursor above the top margin, the cursor stops at the top margin. *Editor Function*

**DA -- Device Attributes**

**ESC [ Pn c** default value: 0

1. The host requests the VT100 to send a device attributes (DA) control sequence to identify itself by sending the DA control sequence with either no parameter or a parameter of 0.
2. Response to the request described above (VT100 to host) is generated by the VT100 as a DA control sequence with the numeric parameters as follows:

<b>Option Present</b>	<b>Sequence Sent</b>
No options	ESC [?1;0c
Processor option (STP)	ESC [?1;1c
Advanced video option (AVO)	ESC [?1;2c
AVO and STP	ESC [?1;3c
Graphics option (GPO)	ESC [?1;4c
GPO and STP	ESC [?1;5c
GPO and AVO	ESC [?1;6c

**Option Present****Sequence Sent**

GPO, STP and AVO

ESC [?1;7c

**DECALN -- Screen Alignment Display (DEC Private)****ESC # 8**

This command fills the entire screen area with uppercase Es for screen focus and alignment. This command is used by DEC manufacturing and Field Service personnel.

**DECANM -- ANSI/VT52 Mode (DEC Private)**

This is a private parameter applicable to set mode (SM) and reset mode (RM) control sequences. The reset state causes only VT52 compatible escape sequences to be interpreted and executed. The set state causes only ANSI "compatible" escape and control sequences to be interpreted and executed.

**DECARM -- Auto Repeat Mode (DEC Private)**

This is a private parameter applicable to set mode (SM) and reset mode (RM) control sequences. The reset state causes no keyboard keys to auto-repeat. The set state causes certain keyboard keys to auto-repeat.

**DECAWM -- Autowrap Mode (DEC Private)**

This is a private parameter applicable to set mode (SM) and reset mode (RM) control sequences. The reset state causes any displayable characters received when the cursor is at the right margin to replace any previous characters there. The set state causes these characters to advance to the start of the next line, doing a scroll up if required and permitted.

**DECCKM -- Cursor Keys Mode (DEC Private)**

This is a private parameter applicable to set mode (SM) and reset mode (RM) control sequences. This mode is only effective when the terminal is in keypad application mode (see DECKPAM) and the ANSI/VT52 mode (DECANM) is set (see DECANM). Under these conditions, if the cursor key mode is reset, the four cursor function keys will send ANSI cursor control commands. If cursor key mode is set, the four cursor function keys will send application functions.

**DECCOLM -- Column Mode (DEC Private)**

This is a private parameter applicable to set mode (SM) and reset mode (RM) control sequences. The reset state causes a maximum of 80 columns on the screen. The set state causes a maximum of 132 columns on the screen.

#### **DECDHL -- Double Height Line (DEC Private)**

Top Half: **ESC # 3**

Bottom Half: **ESC # 4**

These sequences cause the line containing the active position to become the top or bottom half of a double-height double-width line. The sequences must be used in pairs on adjacent lines and the same character output must be sent to both lines to form full double-height characters. If the line was single-width single-height, all characters to the right of the center of the screen are lost. The cursor remains over the same character position unless it would be to the right of the right margin, in which case it is moved to the right margin. *NOTE: The use of double-width characters reduces the number of characters per line by half.*

#### **DECDWL -- Double-Width Line (DEC Private)**

**ESC # 6**

This causes the line that contains the active position to become double-width single-height. If the line was single-width single-height, all characters to the right of the screen are lost. The cursor remains over the same character position unless it would be to the right of the right margin, in which case, it is moved to the right margin.

*NOTE: The use of double-width characters reduces the number of characters per line by half.*

#### **DECID -- Identify Terminal (DEC Private)**

**ESC Z**

This sequence causes the same response as the ANSI device attributes (DA). This sequence will not be supported in future DEC terminals, therefore, DA should be used by any new software.

#### **DECINLM -- Interlace Mode (DEC Private)**

This is a private parameter applicable to set mode (SM) and reset mode (RM) control sequences. The reset state (non-interlace) causes the video processor to display 240 scan lines per frame. The set state (interlace) causes

the video processor to display 480 scan lines per frame. There is no increase in character resolution.

**DECKPAM -- Keypad Application Mode (DEC Private)**

**ESC =**

The auxiliary keypad keys will transmit control sequences as defined in Tables 3-7 and 3-8.

**DECKPNM -- Keypad Numeric Mode (DEC Private)**

**ESC >**

The auxiliary keypad keys will send ASCII codes corresponding to the characters engraved on the keys.

**DECLL -- Load LEDs (DEC Private)**

**ESC [ Ps q** *default value: 0*

Load the four programmable LEDs on the keyboard according to the parameter(s).

<b>Parameter</b>	<b>Parameter Meaning</b>
0	Clear LEDs L1 through L4
1	Light L1
2	Light L2
3	Light L3
4	Light L4

LED numbers are indicated on the keyboard.

**DECOM -- Origin Mode (DEC Private)**

This is a private parameter applicable to set mode (SM) and reset mode (RM) control sequences. The reset state causes the origin to be at the upper-left character position on the screen. Line and column numbers are, therefore, independent of current margin settings. The cursor may be positioned outside the margins with a cursor position (CUP) or horizontal and vertical position (HVP) control.

The set state causes the origin to be at the upper-left character position within the margins. Line and column numbers are therefore relative to the current margin settings. The cursor is not allowed to be positioned outside the margins.

The cursor is moved to the new home position when this mode is set or reset.

Lines and columns are numbered consecutively, with the origin being line 1, column 1.

## DECRC -- Restore Cursor (DEC Private)

### ESC 8

This sequence causes the previously saved cursor position, graphic rendition, and character set to be restored.

## DECREPTPARM -- Report Terminal Parameters

ESC [ <sol>; <par>; <nbits>; <xspeed>; <rspeed>;  
<clkmul>; <flags> x

These sequence parameters are explained below in the DECREQTPARM sequence.

## DECREQTPARM -- Request Terminal Parameters

ESC [ <sol> x

The sequence DECREPTPARM is sent by the terminal controller to notify the host of the status of selected terminal parameters. The status sequence may be sent when requested by the host or at the terminal's discretion. DECREPTPARM is sent upon receipt of a DECREQTPARM. On power-up or reset, the VT100 is inhibited from sending unsolicited reports.

The meanings of the sequence parameters are:

### Parameter Value Meaning

<sol>	0 or none	This message is a request (DECREQTPARM) and the terminal will be allowed to send unsolicited reports. (Unsolicited reports are sent when the terminal exits the SET-UP mode).
	1	This message is a request; from now on the terminal may only report in response to a request.
	2	This message is a report (DECREPTPARM).
<par>	3	This message is a report and the terminal is only reporting on request.
	1	No parity set
	4	Parity is set and odd
<nbits>	5	Parity is set and even
	1	8 bits per character
	2	7 bits per character
<xspeed>, <rspeed>	0	50 Bits per second
	8	75

Parameter	Value	Meaning
	16	110
	24	134.5
	32	150
	40	200
	48	300
	56	600
	64	1200
	72	1800
	80	2000
	88	2400
	96	3600
	104	4800
	112	9600
	120	19200
<clkmul>	1	The bit rate multiplier is 16.
<flags>	0-15	This value communicates the four switch values in block 5 of SET UP B, which are only visible to the user when an STP option is installed. These bits may be assigned for an STP device. The four bits are a decimal-encoded binary number.

#### **DECSC -- Save Cursor (DEC Private)**

##### **ESC 7**

This sequence causes the cursor position, graphic rendition, and character set to be saved. (See DECRC).

#### **DECSCLM -- Scrolling Mode (DEC Private)**

This is a private parameter applicable to set mode (SM) and reset mode (RM) control sequences. The reset state causes scrolls to "jump" instantaneously. The set state causes scrolls to be "smooth" at a maximum rate of six lines per second.

#### **DECSCNM -- Screen Mode (DEC Private)**

This is a private parameter applicable to set mode (SM) and reset mode (RM) control sequences. The reset state causes the screen to be black with white characters. The

set state causes the screen to be white with black characters.

#### **DECSTBM -- Set Top and Bottom Margins (DEC Private)**

**ESC [ Pn; Pn r** *default values: see below*

This sequence sets the top and bottom margins to define the scrolling region. The first parameter is the line number of the first line in the scrolling region; the second parameter is the line number of the bottom line in the scrolling region. Default is the entire screen (no margins). The minimum size of the scrolling region allowed is two lines, i.e., the top margin must be less than the bottom margin. The cursor is placed in the home position (see Origin Mode DECOM).

#### **DECSWL -- Single-width Line (DEC Private)**

**ESC # 5**

This causes the line which contains the active position to become single-width single-height. The cursor remains on the same character position. This is the default condition for all new lines on the screen.

#### **DECTST -- Invoke Confidence Test**

**ESC [ 2 ; Ps y**

Ps is the parameter indicating the test to be done. Ps is computed by taking the weight indicated for each desired test and adding them together. If Ps is 0, no test is performed but the VT100 is reset.

<b>Test</b>	<b>Weight</b>
Power up self-test (ROM check sum, RAM, NVR keyboard and AVO if installed)	1
Data Loop Back	2 (loop back connector required)
EIA modem control test	4 (loop back connector required)
Repeat Selected Test(s) indefinitely (until failure or power off)	8

#### **DSR -- Device Status Report**

**ESC [ Ps n** *default value: 0*

Requests and reports the general status of the VT100 according to the following parameter(s).

**Parameter Parameter Meaning**

- |   |   |
|---|---|
| 0 | Response from VT100 -- Ready, No malfunctions detected (default)                  |
| 3 | Response from VT100 -- Malfunction -- retry                                       |
| 5 | Command from host -- Please report status (using a DSR control sequence)          |
| 6 | Command from host -- Please report active position (using a CPR control sequence) |

DSR with a parameter value of 0 or 3 is always sent as a response to a requesting DSR with a parameter value of 5.

**ED -- Erase In Display**

**ESC [ Ps J** *default value: 0*

This sequence erases some or all of the characters in the display according to the parameter. Any complete line erased by this sequence will return that line to single width mode. *Editor Function*

**Parameter Parameter Meaning**

- |   |  |
|---|--|
| 0 | Erase from the active position to the end of the screen, inclusive (default)                             |
| 1 | Erase from start of the screen to the active position, inclusive   |
| 2 | Erase all of the display -- all lines are erased, changed to single-width, and the cursor does not move. |

**EL -- Erase In Line**

**ESC [ Ps K** *default value: 0*

Erases some or all characters in the active line according to the parameter. *Editor Function*

**Parameter Parameter Meaning**

- |   |  |
|---|--|
| 0 | Erase from the active position to the end of the line, inclusive (default) |
| 1 | Erase from the start of the screen to the active position, inclusive       |
| 2 | Erase all of the line, inclusive   |

**HTS -- Horizontal Tabulation Set**

## **ESC H**

Set one horizontal stop at the active position. *Format Effector*

## **HVP -- Horizontal and Vertical Position**

**ESC [ Pn ; Pn f** *default value: 1*

Moves the active position to the position specified by the parameters. This sequence has two parameter values, the first specifying the line position and the second specifying the column. A parameter value of either zero or one causes the active position to move to the first line or column in the display, respectively. The default condition with no parameters present moves the active position to the home position. In the VT100, this control behaves identically with its editor function counterpart, CUP. The numbering of lines and columns depends on the reset or set state of the origin mode (DECOM). *Format Effector*

## **IND -- Index**

## **ESC D**

This sequence causes the active position to move downward one line without changing the column position. If the active position is at the bottom margin, a scroll up is performed. *Format Effector*

## **LNM -- Line Feed/New Line Mode**

This is a parameter applicable to set mode (SM) and reset mode (RM) control sequences. The reset state causes the interpretation of the line feed (LF), defined in ANSI Standard X3.4-1977, to imply only vertical movement of the active position and causes the **RETURN** key (CR) to send the single code CR. The set state causes the LF to imply movement to the first position of the following line and causes the **RETURN** key to send the two codes (CR, LF). This is the New Line (NL) option. This mode does not affect the index (IND), or next line (NEL) format effectors.

## **NEL -- Next Line**

## **ESC E**

This sequence causes the active position to move to the first position on the next line downward. If the active position is at the bottom margin, a scroll up is performed. *Format Effector*

## RI -- Reverse Index

### ESC M

Move the active position to the same horizontal position on the preceding line. If the active position is at the top margin, a scroll down is performed. *Format Effector*

## RIS -- Reset To Initial State

### ESC c

Reset the VT100 to its initial state, i.e., the state it has after it is powered on. This also causes the execution of the power-up self-test and signal INIT H to be asserted briefly.

## RM -- Reset Mode

**ESC [ Ps ; Ps ; . . . ; Ps l** *default value: none*

Resets one or more VT100 modes as specified by each selective parameter in the parameter string. Each mode to be reset is specified by a separate parameter. [See Set Mode (SM) control sequence]. (See Modes following this section).

## SCS -- Select Character Set

The appropriate G0 and G1 character sets are designated from one of the five possible character sets. The G0 and G1 sets are invoked by the codes SI and SO (shift in and shift out) respectively.

G0 Sets Sequence	G1 Sets Sequence	Meaning
ESC ( A	ESC ) A	United Kingdom Set
ESC ( B	ESC ) B	ASCII Set
ESC ( 0	ESC ) 0	Special Graphics
ESC ( 1	ESC ) 1	Alternate Character ROM Standard Character Set
ESC ( 2	ESC ) 2	Alternate Character ROM Special Graphics

The United Kingdom and ASCII sets conform to the "ISO international register of character sets to be used with escape sequences". The other sets are private character sets. Special graphics means that the graphic characters for the codes 137<sub>8</sub> to 176<sub>8</sub> are replaced with other characters. The specified character set will be used until another SCS is received.

*NOTE: Additional information concerning the SCS escape sequence may be obtained in ANSI standard X3.41-1974.*

### **SGR -- Select Graphic Rendition**

**ESC [ Ps ; . . . ; Ps m** *default value: 0*

Invoke the graphic rendition specified by the parameter(s). All following characters transmitted to the VT100 are rendered according to the parameter(s) until the next occurrence of SGR. *Format Effector*

<b>Parameter</b>	<b>Parameter Meaning</b>
0	Attributes off
1	Bold or increased intensity
4	Underscore
5	Blink
7	Negative (reverse) image

All other parameter values are ignored.

With the Advanced Video Option, only one type of character attribute is possible as determined by the cursor selection; in that case specifying either the underscore or the reverse attribute will activate the currently selected attribute. (See cursor selection in Chapter 1).

### **SM -- Set Mode**

**ESC [ Ps ; . . . ; Ps h** *default value: none*

Causes one or more modes to be set within the VT100 as specified by each selective parameter in the parameter string. Each mode to be set is specified by a separate parameter. A mode is considered set until it is reset by a reset mode (RM) control sequence.

### **TBC -- Tabulation Clear**

**ESC [ Ps g** *default value: 0*

#### **Parameter Parameter Meaning**

0	Clear the horizontal tab stop at the active position (the default case).
3	Clear all horizontal tab stops.

Any other parameter values are ignored. *Format Effector*

### **Modes**

The following is a list of VT100 modes which may be changed with set mode (SM) and reset mode (RM) controls.

## ANSI Specified Modes

Parameter	Mode Mnemonic	Mode Function
0		Error (ignored)
20	LNLM	Line feed new line mode

## DEC Private Modes

If the first character in the parameter string is ? (77<sub>8</sub>), the parameters are interpreted as DEC private parameters according to the following:

Parameter	Mode Mnemonic	Mode Function
0		Error (ignored)
1	DECCKM	Cursor key
2	DECANM	ANSI/VT52
3	DECCOLM	Column
4	DECSCLM	Scrolling
5	DECSCNM	Screen
6	DECOM	Origin
7	DECAWM	Auto wrap
8	DECARM	Auto repeating
9	DECINLM	Interlace

Any other parameter values are ignored.

The following modes, which are specified in the ANSI X3.64-1977 standard, may be considered to be permanently set, permanently reset, or not applicable, as noted. Refer to that standard for further information concerning these modes.

Mode Mnemonic	Mode Function	State
CRM	Control representation	Reset
EBM	Editing boundary	Reset
ERM	Erasure	Set
FEAM	Format effector action	Reset
FETM	Format effector transfer	Reset
GATM	Guarded area transfer	NA
HEM	Horizontal editing	NA
IRM	Insertion-replacement	Reset
KAM	Keyboard action	Reset
MATM	Multiple area transfer	NA
PUM	Positioning unit	Reset
SATM	Selected area transfer	NA

<b>Mode Mnemonic</b>	<b>Mode Function</b>	<b>State</b>
SRTM	Status reporting transfer	Reset
TSM	Tabulation stop	Reset
TTM	Transfer termination	NA
VEM	Vertical editing	NA

### **Valid VT52 Mode Control Sequences**

#### **Cursor Up**

##### **ESC A**

Move the active position upward one position without altering the horizontal position. If an attempt is made to move the cursor above the top margin, the cursor stops at the top margin.

#### **Cursor Down**

##### **ESC B**

Move the active position downward one position without altering the horizontal position. If an attempt is made to move the cursor below the bottom margin, the cursor stops at the bottom margin.

#### **Cursor Right**

##### **ESC C**

Move the active position to the right. If an attempt is made to move the cursor to the right of the right margin, the cursor stops at the right margin.

#### **Cursor Left**

##### **ESC D**

Move the active position one position to the left. If an attempt is made to move the cursor to the left of the left margin, the cursor stops at the left margin.

#### **Enter Graphics Mode**

##### **ESC F**

Causes the special graphics character set to be used.  
*NOTE: The special graphics characters in the VT100 are different from those in the VT52.*

#### **Exit Graphics Mode**

### **ESC G**

This sequence causes the standard ASCII character set to be used.

### **Cursor to Home**

### **ESC H**

Move the cursor to the home position.

### **Reverse Line Feed**

### **ESC I**

Move the active position upward one position without altering the column position. If the active position is at the top margin, a scroll down is performed.

### **Erase to End of Screen**

### **ESC J**

Erase all characters from the active position to the end of the screen. The active position is not changed.

### **Erase to End of Line**

### **ESC K**

Erase all characters from the active position to the end of the current line. The active position is not changed.

### **Direct Cursor Address**

### **ESC Y line column**

Move the cursor to the specified line and column. The line and column numbers are sent as ASCII codes whose values are the number plus 037<sub>8</sub>; e.g., 040<sub>8</sub> refers to the first line or column, 050<sub>8</sub> refers to the eighth line or column, etc.

### **Identify**

### **ESC Z**

This sequence causes the terminal to send its identifier escape sequence to the host. This sequence is:

**ESC / Z**

### **Enter Alternate Keypad Mode**

## **ESC =**

The optional auxiliary keypad keys will send unique identifiable escape sequences for use by applications programs.

*NOTE: Information regarding options must be obtained in ANSI mode, using the device attributes (DA) control sequences.*

## **Exit Alternate Keypad Mode**

## **ESC >**

The optional auxiliary keypad keys send the ASCII codes for the functions or characters engraved on the key.

## **Enter ANSI Mode**

## **ESC <**

All subsequent escape sequences will be interpreted according to ANSI Standards X3.64-1977 and X3.41-1974. The VT52 escape sequence designed in this section will not be recognized.

## **Control Sequence Summary**

The following is a summary of the VT100 control sequences.

## **ANSI Compatible Mode**

### **Cursor Movement Commands**

Cursor up	ESC [ Pn A
Cursor down	ESC [ Pn B
Cursor forward (right)	ESC [ Pn C
Cursor backward (left)	ESC [ Pn D
Direct cursor addressing	ESC [ Pl ; Pc H† or ESC [ Pl ; Pc f†
Index	ESC D
New line	ESC E
Reverse index	ESC M
Save cursor and attributes	ESC 7
Restore cursor and attributes	ESC 8

† Pl = line number; Pc = column number

*NOTE: Pn refers to a decimal parameter expressed as a string of ASCII digits. Multiple parameters are separated by the semicolon character (073<sub>8</sub>). If a parameter is omitted or specified to be 0 the default parameter value*

is used. For the cursor movement commands, the default parameter value is 1.

#### **Line Size (Double-Height and Double-Width) Commands**

Change this line to double-height top half      ESC # 3

Change this line to double-height bottom half   ESC # 4

Change this line to single-width single-height   ESC # 5

Change this line to double-width single-height   ESC # 6

#### **Character Attributes**

ESC [ Ps;Ps;Ps;...;Ps m

Ps refers to a selective parameter. Multiple parameters are separated by the semicolon character (073<sub>8</sub>). The parameters are executed in order and have the following meanings:

0 or None All Attributes Off

1            Bold on

4            Underscore on

5            Blink on

7            Reverse video on

Any other parameter values are ignored.

#### **Erasing**

From cursor to end of line                    ESC [ K or ESC [ 0 K

From beginning of line to cursor            ESC [ 1 K

Entire line containing cursor                ESC [ 2 K

From cursor to end of screen                ESC [ J or ESC [ 0 J

From beginning of screen to cursor        ESC [ 1 J

Entire screen                                ESC [ 2 J

#### **Programmable LEDs**

ESC [ Ps;Ps;...Ps q

Ps are selective parameters separated by semicolons (073<sub>8</sub>) and executed in order, as follows:

0 or None All LEDs Off

1            L1 On

2            L2 On

3            L3 On

4            L4 On

Any other parameter values are ignored.

#### **Character Sets (G0 and G1 Designators)**

The G0 and G1 character sets are designated as follows:

<b>Character set</b>	<b>G0 designator</b>	<b>G1 designator</b>
United Kingdom (UK)	ESC ( A	ESC ) A
United States (USASCII)	ESC ( B	ESC ) B

Character set	G0 designator	G1 designator
Special graphics characters and line drawing set	ESC ( 0	ESC ) 0
Alternate character ROM	ESC ( 1	ESC ) 1
Alternate character ROM special graphics characters	ESC ( 2	ESC ) 2

### Scrolling Region

ESC [ Pt ; Pb r

Pt is the number of the top line of the scrolling region; Pb is the number of the bottom line of the scrolling region and must be greater than Pt.

### Tab Stops

Set tab at current column ESC H

Clear tab at current column ESC [ g or ESC [ 0 g

Clear all tabs ESC [ 3 g

### Modes

Mode Name	To Set		To Reset	
	Mode	Sequence	Mode	Sequence
Line feed/new line	New line	ESC [20h	Line feed	ESC [20l*
Cursor key mode	Application	ESC [?1h	Cursor	ESC [?1l*
ANSI/VT52 mode	ANSI	N/A	VT52	ESC [?2l*
Column mode	132 Col	ESC [?3h	80 Col	ESC [?3l*
Scrolling mode	Smooth	ESC [?4h	Jump	ESC [?4l*
Screen mode	Reverse	ESC [?5h	Normal	ESC [?5l*
Origin mode	Relative	ESC [?6h	Absolute	ESC [?6l*
Wraparound	On	ESC [?7h	Off	ESC [?7l*
Auto repeat	On	ESC [?8h	Off	ESC [?8l*
Interlace	On	ESC [?9h	Off	ESC [?9l*
Keypad mode	Application	ESC =	Numeric	ESC >

\* The last character of the sequence is a lowercase L (154<sub>8</sub>).

### Reports

#### Cursor Position Report

Invoked by ESC [ 6 n

Response is ESC [ Pl ; Pc R †

† Pl = line number; Pc = column number

#### Status Report

Invoked by ESC [ 5 n

Response is ESC [ 0 n (terminal ok)

ESC [ 3 n (terminal not ok)

### What Are You

Invoked by `ESC [ c` or `ESC [ 0 c`

Response is `ESC [ ? 1 ; Ps c`

Ps is the "option present" parameter with the following meaning:

#### **Ps Meaning**

- 0 Base VT100, no options
- 1 Processor options (STP)
- 2 Advanced video option (AVO)
- 3 AVO and STP
- 4 Graphics processor option (GPO)
- 5 GPO and STP
- 6 GPO and AVO
- 7 GPO, STP, and AVO

Alternatively invoked by `ESC Z` (not recommended).

Response is the same.

#### **Reset**

Reset causes the power-up reset routine to be executed.

`ESC c`

#### **Confidence Tests**

Fill Screen with "Es" `ESC # 8`

Invoke Test(s) `ESC [ 2 ; Ps y`

Ps is the parameter indicating the test to be done and is a decimal number computed by taking the "weight" indicated for each desired test and adding them together.

<b>Test</b>	<b>Weight</b>
Power-up self test (ROM checksum, RAM, NVR, keyboard and AVO if installed)	1
Data Loop Back	2 (loop back connector required)
EIA modem control test	4 (loop back connector required)
Repeat selected test(s) indefinitely (until failure or power off)	8

#### **VT52 Compatible Mode**

The following is a summary of the VT100 control sequences.

Cursor Up	<code>ESC A</code>
Cursor Down	<code>ESC B</code>
Cursor Right	<code>ESC C</code>

Cursor Left	ESC D	
Select Special Graphics character set	ESC F	
Select ASCII character set	ESC G	
Cursor to home	ESC H	
Reverse line feed	ESC I	
Erase to end of screen	ESC J	
Erase to end of line	ESC K	
Direct cursor address	ESC Y l	(see note 1)
	c	
Identify	ESC Z	(see note 2)
Enter alternate keypad mode	ESC =	
Exit alternate keypad mode	ESC >	
Enter ANSI mode	ESC <	

NOTE 1: Line and column numbers for direct cursor address are single character codes whose values are the desired number plus  $37_8$ . Line and column numbers start at 1.

NOTE 2: Response to ESC Z is ESC / Z.

# Chapter 4

## VT100 Options

The VT100 has available options which are designed to enhance the basic terminal and allow its use in a wide range of applications. The options currently available are:

- VT1XX-AA 20 Current Loop Option
- VT1XX-AB Advanced Video Option

In the future, additional options will be available which will further enhance the basic VT100. Contact the nearest DIGITAL Sales Office for further information and how to order the options.

### **Advanced Video Option -- VT1XX-AB**

The Advanced Video Option enhances the basic VT100 by adding the following features:

- 10 additional lines of 132 column display -- this capability is added to the VT100 by providing additional display memory. The screen can now display a total of 24 lines in either 80- or 132-column format.
- Additional character attributes -- the VT100 is now capable of highlighting any character(s) on the screen in any of the following ways:
  - Bold
  - Blink
  - Underline
  - Reverse
  - Any combination of the above
- Capability of an additional character generator ROM -- this capability is added to the VT100 by providing the memory required to access a second character generator ROM.

### **Advanced Video Option Installation**

Use the following procedure to install the Advanced Video Option.

1. Remove power from the terminal by disconnecting the ac plug.
2. Unplug the keyboard (Figure 4-1).
3. Unplug any connectors from the composite video input/output jacks.
4. Disconnect the communications cable.
5. With a blade-type screwdriver loosen the four captive screws holding the access cover.
6. If the 20 mA Current Loop Option is installed, gently pull the access cover away from the terminal about 2 inches; then reach in and disconnect J5 from the terminal controller board.
7. Remove the access cover.
8. Remove any graphic or STP cables.
9. Remove the terminal controller board by gently but firmly pulling the board straight out. The terminal controller board is located in the leftmost slot in the card cage (viewed from the rear).
10. Place the terminal controller board on a flat surface with the component side up (Figure 4-2).
11. Locate the four mounting holes drilled in the terminal controller board; mount a standoff in each.
12. Grasp the advanced video board by the edges and carefully align the connector pins with the connector on the terminal controller board. Gently but firmly mount the advanced video board onto the terminal controller board.
13. Reinstall the terminal controller board. The terminal controller board must be inserted into the leftmost slot in the card cage.
14. Reinstall all cables removed.
15. Reinstall the access cover.

### **Advanced Video Option Checkout**

Use the following procedure to check out the operation of the Advanced Video Option.

1. Turn the terminal power on and verify that no error was detected during the power up self-test.
2. Press the SET-UP key. The words "SET-UP A" should blink in boldface, the words "TO EXIT PRESS SET-UP" should be underlined, and the ruler should contain alternating normal and reverse video fields.
3. Place the terminal in the 132-column mode and then in the LOCAL mode.
4. Exit SET-UP and type the following sequence:

ESC < ESC # 8

The screen should now display 24 lines × 132 columns.

## **20 mA Current Loop Option -- VT1XX-AA**

The 20 mA Current Loop Option allows the VT100 to connect directly to the host computer over a short distance without using a modem. The specifications for the 20 mA Current Loop Option are located in Chapter 2 of this manual under interface information.

### **20 mA Current Loop Option Installation**

Use the following procedure to install the 20 mA Current Loop Option:

1. Remove power from the terminal by disconnecting the ac plug.
2. Unplug the keyboard.
3. Unplug any connectors from the composite video input/output jacks.
4. Disconnect the communications cable.
5. With a blade-type screwdriver loosen the four captive screws holding the access cover; then remove the cover.
6. Set the TRANS switch to the NORMAL position (Figure 4-3). (If the terminal must provide current on the receive line, set the switch to the ACT position).
7. Set the REC switch to the NORMAL position (Figure 4-3). (If the terminal must provide current on the receive line set the switch to the ACT position).
8. Connect P5 to J5 on the terminal controller board (Figure 4-4).
9. Perform the 20 mA Current Loop Option Checkout.

### **20 mA Current Loop Option Checkout**

The VT100 contains an internal test called the data loopback test. In the data loopback test the VT100 transmit and receive lines are connected to each other via a special external connector. A predefined set of characters are then transmitted. The terminal receives the characters and compares them to the characters transmitted. If the characters do not match an error is then flagged.

Use the following procedure to check out the operation of the 20 mA Current Loop Option.

1. Disconnect the terminal from the communications line.

2. Remove the terminal access cover containing the 20 mA current loop board; place both of the switches in the NORMAL position. Reinstall the access cover.
3. Connect the 20 mA loopback connector (PN 70-15503-00) to the Mate-N-Lok connector mounted to the bottom of the access cover.
4. Place the terminal in ANSI-compatible mode (in SETUP B group 2 switch 3 equals a 1).
5. Type the following sequence to perform the data loopback test.

ESC [ 2 ; 2 y

When the test is performed, the screen clears and the message "WAIT" is displayed in the upper left corner of the screen. The entire test takes approximately six seconds to run.

*NOTE: The data loopback test can be repeated indefinitely by typing ESC [ 2; 10 y. This test ends only when an error is detected or the terminal power is turned off.*

6. A loopback error is shown by "8" being displayed in the upper left corner of the screen. If an error is detected, check the 20 mA board connectors and switch settings and then repeat Step 5. If the error persists, contact your service organization.
7. Once the test is complete return the 20 mA current loop board switches to the original positions, remove the loopback connector, replace the access cover, and reconnect the terminal to communications line.

## **Communications Cables**

The communications cables available for use with the VT100 are listed in Chapter 5.

# Chapter 5

## Accessories and Supplies

### General

The VT100 video terminal is a data transaction terminal supporting a wide variety of user-controllable character and screen attributes. Additional features include smooth scrolling, selectable column widths and typewriter-like detachable keyboard. The following describes VT100 supplies and accessories.

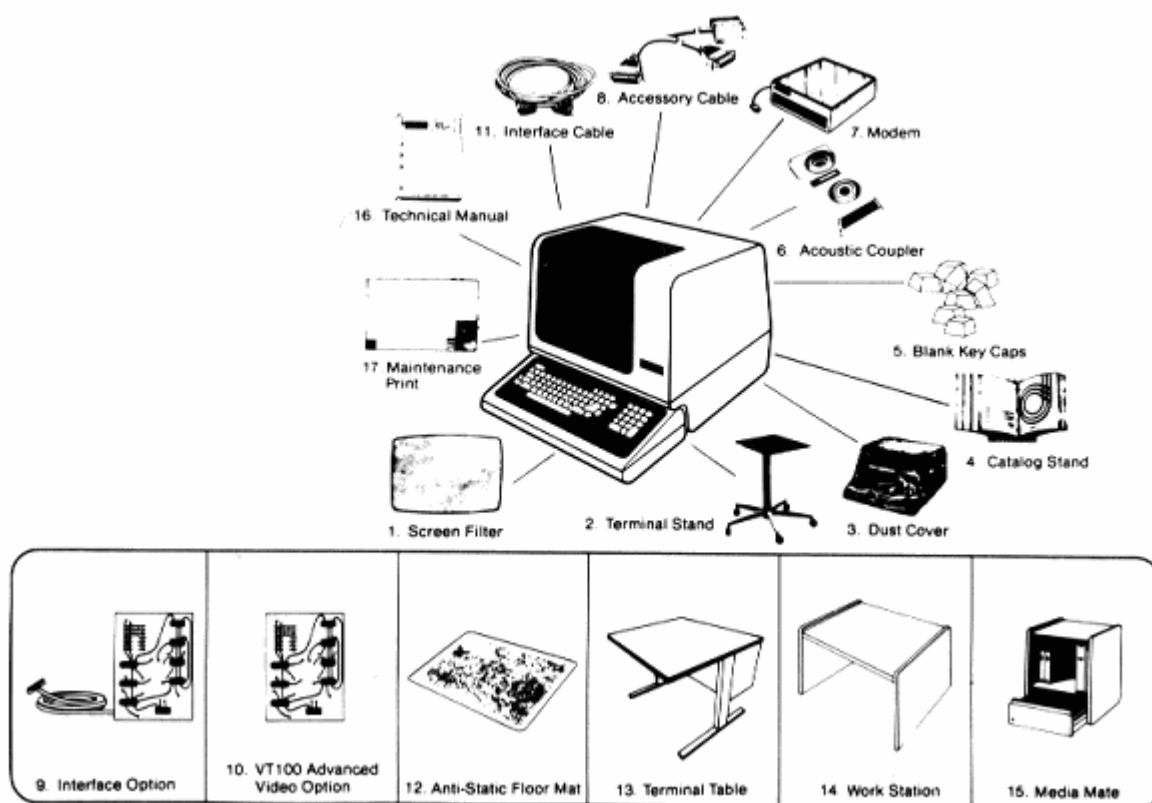

### Supplies

Item Number	DEC Part Number	Description
1	VT1XX-AE	VT100 formed screen filter, gray antiglare coating
1	VT1XX-AR	VT100 nonreflective filter screen
2	VT1XX-ST	VT100 terminal stand with casters
2	VT1XX-SU	VT100 terminal table (VT1XX-ST), lot of 25
2	VT1XX-SV	VT100 terminal table (VT1XX-ST), lot of

Item Number	DEC Part Number	Description
		50
3	H9850-HK	Heavy gauge vinyl dust cover, charcoal brown
4	H980-CS	Catalog stand with eight one-inch removable cartridges for 8½ inches × 11 inches documentation
4	H980-CP	Cartridges for catalog stand
5	LA12X-UA	Blank keycap kit of 50, Row 4*
5	LA12X-UB	Blank keycap kit of 50, Row 1*
5	LA12X-UC	Blank keycap kit of 50, Row 2*
5	LA12X-UD	Blank keycap kit of 50, F&J type
5	LA12X-UE	Blank keycap kit of 50, SET-UP
5	LA12X-UF	Blank keycap kit of 50, TAB
5	LA12X-UH	Blank keycap kit of 50, CAP LOCK
5	LA12X-UJ	Blank keycap kit of 50, SHIFT
5	LA12X-UL	Main array blank keycap set

\* Row 1 is the row immediately above Space Bar

Item Number	DEC Part Number	Description
5	LA12X-UM	Blank keycap kit of 50, CR
5	LA12X-UN	Blank keycap kit of 50, ENTER
5	LA12X-UP	Blank keycap kit of 50, Num Pad 0
5	LA12X-UR	Blank keycap kit of 50, Row 3*
5	LA12X-US	Blank keycap kit of 50, Row 5*
5	LA12X-UT	Numeric pad blank keycap set
6	DF01-A	Acoustic telephone coupler, 300 bps with combination EIA (RS232-C) and 20 mA current loop cable
7	DF02-AA	Direct connect, Bell 103J equivalent, 300 bps full-duplex modem with EIA RS232-C interface
8	30-10958-02	Cable to interface older DF01 couplers to VT100
9	VT1XX-AA	VT100 20 mA current loop option with cable
9	VT1XX-AC	VT100 printer port
10	VT1XX-AB	VT100 advanced video option
11	BC03M-50	Female-female null modem cable, 50 ft

Item Number	DEC Part Number	Description
		(15.2 m)
11	BC03M-A0	Female-female null modem cable, 100 ft (30.5 m)
11	BC03M-B5	Female-female null modem cable, 250 ft (76.2 m)
11	BC03M-E0	Female-female null modem cable, 500 ft (152.4 m)

\* Row 1 is the row immediately above Space Bar

Item Number	DEC Part Number	Description
11	BC05D-10†	RS-232 female to RS-232 male: EIA extension cable (14 conductor) used with VT100 for modem connections, 10 ft (3.0 m)
11	BC05D-25†	RS-232 female to RS-232 male: EIA extension cable (14 conductor) used with VT100 for modem connections, 25 ft (7.6 m)
11	BC05D-50†	RS-232 female to RS-232 male: EIA extension cable (14 conductor) used with VT100 for modem connections, 50 ft (15.2 m)
11	BC05F-15†	MATE-N-LOK to MATE-N-LOK: 20 mA; direct connection between VT100 with a 20 mA option installed and a line unit, 15 ft (4.6 m)
11	BC05F-50†	MATE-N-LOK to MATE-N-LOK: 20 mA; direct connection between VT100 with a 20 mA option installed and a line unit, 50 ft (15.2 m)
11	BC05F-A0†	MATE-N-LOK to MATE-N-LOK: 20 mA; direct connection between VT100 with a 20 mA option installed and a line unit, 100 ft (30.5 m)
11	BC03M-LO	Female-female null modem cable, 1000 ft (304.8 m)
11	BC05X-15	20 mA current loop extension cable, 15 ft (4.6 m)
11	BC05X-25	20 mA current loop extension cable, 25 ft (7.6 m)
11	BC05X-50	20 mA current loop extension cable, 50 ft (15.2 m)

Item Number	DEC Part Number	Description
----------------	--------------------	-------------

† For use with a DF01-A Acoustic Coupler. Pin 23 of this cable must be disconnected.

‡ A BC05F-15 cable is shipped with the VT1XX-AA option.

Item Number	DEC Part Number	Description
----------------	--------------------	-------------

11	BC22A-10	EIA RS232 female-female null modem cable shielded 10 ft (3.0 m)
11	BC22A-25	EIA RS232 female-female null modem cable shielded 25 ft (7.6 m)
11	BC22B-10§	EIA RS232 male-female extension cable shielded 10 ft (3.0 m)
11	BC22B-25§	EIA RS232 male-female extension cable shielded 25 ft (7.6 m)
11	BC23A-10	Kit of 5 BC22A-10
11	BC23A-25	Kit of 5 BC22A-25
11	BC23B-10	Kit of 5 BC22B-10
11	BC23B-25	Kit of 5 BC22B-25
12	H9850-DA	Anti-static floor mat, DECmat, 4 ft × 6 ft (122 cm × 183 cm), Driftwood color (brownish/gray)
12	H9850-DB	Anti-static floor mat, DECmat, 4 ft × 6 ft (122 cm × 183 cm), Summer Earth color (brown/gold)
12	H9850-DC	Anti-static floor mat, DECmat, 3 ft × 10 ft (91 cm × 305 cm), Silver Birch color (silvergray/brown)
12	H9850-DD	Anti-static floor mat, DECmat, 3 ft × 10 ft (91 cm × 305 cm), Autumn Bronze color (orange/brown)
12	H9850-DE	Anti-static floor mat, DECmat, 3 ft × 10 ft (91 cm × 305 cm), Driftwood color (brownish/gray)

§ This cable cannot be used with a DF01-A Acoustic Coupler. Use cable BC05D-XX in its place.

Item Number	DEC Part Number	Description
----------------	-----------------------	-------------

12	H9850-DF	Anti-static floor mat, DECmat, 4 ft × 6 ft (122 cm × 183 cm), Silver Birch color
----	----------	--

Item Number	DEC Part Number	Description
		(silvergray/brown)
12	H9850-DH	Anti-static floor mat, DECmat, 4 ft x 6 ft (122 cm x 183 cm), Autumn Bronze color (orange/brown)
13	H970-EB	Terminal table, 27 inches high x 36 inches wide x 30 inches deep (68.6 cm x 91.4 cm x 76.2 cm) with levelers
13	H970-HB	Terminal table, 27 inches high x 24 inches wide x 30 inches deep (68.6 cm x 61.0 cm x 76.2 cm) with levelers
14	H9532-AA	Work-station desk with blue front panel and gray side panels, levelers, 48 inches wide x 30 inches high x 30 inches deep (122 cm x 76.2 cm x 76.2 cm)
14	H9532-AB	Work-station desk with brown front panel and brown side panels, levelers, 48 inches wide x 30 inches high x 30 inches deep (122 cm x 76.2 cm x 76.2 cm)
14	H9614-AB	Split top add-on work station, one side panel
14	H9614-AD	Split top standalone unit
14	H9614-AF	Split top dual add-on unit (uses H9610 end panels for support)
15	H9850-AP	Media Mate™, file or shelf storage cart with with casters and lockable drawer, 25.25 inches high x 15 inches deep x 18.5 inches wide (64.1 cm x 38.1 cm x 47.0 cm)
16	EK-18251-20	Terminals and Communications Handbook
16	EK-VT100-UG	VT100 User's Guide

Item Number	DEC Part Number	Description
16	EK-VT100-J1	VT100 Mini Maintenance Manual
16	EK-VT100-IP	VT100 Video Terminal IPB
16	EK-VT100-RC	VT100 Program Reference Manual
16	EK-VT100-TM	VT100 Technical Manual
17	MP-00633	VT100 Maintenance Prints

## Spares Kit

Item Number	DEC Part Number	Description
--	4A-VT100	VT100 Spares Kit
--	4A-LOTVT-AA	Lot of 10, 30-16080-01, XFRMR, fly back (ELSTON)
--	4A-LOTVT-AB	Lot of 10, 30-16080-02, PC Board Assy (ELSTON)
--	4A-LOTVT-AC	Lot of 10, 54-13009, VT100 Basic Video
--	4A-LOTVT-AD	Lot of 10, 70-14979, Power Supply Assy
--	4A-LOTVT-AE	Lot of 10, 70-15765, Keybrd/Keycap Assy

## How To Order

### Telephone Orders

Continental USA call	800-258-1710 (8:30 am to 6:00 pm EST)
In New Hampshire, call	603-884-6660 (8:30 am to 6:00 pm EST)
In Alaska, and Hawaii, call	408-734-4915 (8:15 am to 5:00 pm PST)

### Important Information Concerning Telephone Orders

- Minimum order of \$100.00 unless charges to MasterCard or VISA.
- Maximum order of \$5,000.00
- Phone orders are accepted at current list price only.
- Phone orders are accepted per DIGITAL standard terms and conditions.

### Direct Mail Orders

Purchase orders should be mailed directly to:

#### US Customers

DIGITAL EQUIPMENT CORPORATION  
PO Box CS2008  
Nashua, New Hampshire 03061

#### International Customers

DIGITAL EQUIPMENT CORPORATION  
A&SG Business Manager  
c/o DIGITAL's local subsidiary

### Important Information Concerning Direct Mail Orders

- Minimum order value of \$100.00 unless paid by check, money order, or credit card (MasterCard or VISA)
- No maximum order value
- Purchase orders may also be submitted to your local DIGITAL Sales Office.

# Appendix A

## ANSI Definitions and Notation

### ANSI Definitions

#### Active position

The character position on the visual display that is to display the graphic symbol representing the next graphic character.

#### ANSI mode

A VT100 mode in which it recognizes and responds only to escape sequences whose syntax and semantics are in accordance with ANSI specifications.

#### Character position

That portion of a visual display which is displaying or is capable of displaying a graphic symbol.

#### Control

A control character, an escape sequence, or a control sequence that performs a control function.

#### Control character

A character whose occurrence in a particular context initiates, modifies, or stops a control function.

#### Control function

An action that affects the recording, processing, transmission, or interpretation of data.

#### Control sequence

A sequence of characters that is used for control purposes to perform a control function, that begins with the control sequence introducer (CSI) control, and that may contain a parameter string.

#### Control sequence introducer (CSI)

An escape sequence that provides supplementary controls and that is itself a prefix affecting the interpretation of a limited number of contiguous characters.

#### Control string

A string of characters that is used to perform a control function and that is delimited by an opening and closing delimiter control.

#### Cursor

A visual representation of the active position which is either a blinking reverse-video or blinking underline.

#### Cursor control

An editor function that moves the active position.

Default

A function-dependent value that is assumed when no explicit value, or a value of 0, is specified.

Display

The current active area of the screen, i.e., the area inside the scrolling region, or the entire screen, depending on the origin mode.

Editor function

A control that affects the layout or positioning of previously entered or received information in a printing or cathode ray tube display and that is intended to be interpreted and executed without remaining in the data stream. (See format effector).

Escape character (ESC)

A control character that provides supplementary characters (code extension) and that is itself a prefix affecting the interpretation of a limited number of contiguous characters.

Escape sequence

A sequence of characters that is used for control purposes to perform a control function and whose first character is the escape (ESC) control character.

Final character

A character whose bit combination terminates an escape or control sequence designated by F.

Format effector

A control that affects the layout or positioning of information on the screen and that may remain in the data stream subsequent to interpretation and processing. (See editor function).

Graphic character

A character, other than a control character, that has a visual representation normally handwritten, printed, or displayed.

Home

The character position at the origin. [See origin mode (DECOM).]

Intermediate character

A character whose bit combination precedes a final character in an escape or control sequence.

Numeric parameter

A string of bit combinations that represents a number, designated by Pn.

Parameter

1. A string of one or more characters that represent a single value:
2. The value so represented.

Parameter string

A string of characters that represent one or more parameter values.

Selective parameter

A string of bit combinations that selects a subfunction from a specified list of subfunctions, designated by Ps. In general, a control sequence with more than one selective parameter causes the same effect as several control sequences, each with one selective parameter, e.g., CSI Psa; Psb; Psc F is identical to CSI Psa F CSI Psb F CSI Psc F.

VT52 mode

A VT100 mode in which it recognizes and responds only to escape sequences which DEC VT52 type terminals use.

## Notation

I

An intermediate character in an escape sequence or a control sequence, where I is from 408 to 578 inclusive.

F

A Final character in:

1. An escape sequence, where F is from 608 to 1768 inclusive.
2. A control sequence, where F is from 1008 to 1768 inclusive.

Pn

A numeric parameter in a control sequence, where Pn is a string of zero or more characters from 608 to 718 inclusive.

Ps

A variable number of selective parameters in a control sequence, with each selective parameter separated from the other by 738. Ps is a string of zero or more characters from 608 to 718 inclusive and 738.

Example: The format of an escape sequence as defined in American National Standard X3.41-1974 and used in the VT100 is:

ESC I ... I F

Where:

1. ESC is the introducer control character (338) that is named escape.
2. I ... I are the intermediate bit combinations that may or may not be present. I characters are bit

combination 408 to 578 inclusive in both 7- and 8-bit environments.

3. F is the final character. F characters are bit combinations 608 to 1768 inclusive in escape sequences in both 7- and 8-bit environments.
4. The occurrence of characters in the inclusive ranges of 08 to 378 within an escape or control sequence, is technically an error condition whose recovery is to execute immediately the function specified by the character and then continue with the escape sequence execution. The exceptions are: If the character ESC occurs, the current escape sequence is aborted, and a new one commences, beginning with the ESC just received. If the character CAN (308) or the character SUB (328) occurs, the current escape sequence is aborted.

# Appendix B

## 7-Bit ASCII Code

Octal Code	Char	Octal Code	Char	Octal Code	Char	Octal Code	Char
000	NUL	040	SP	100	@	140	`
001	SOH	041	!	101	A	141	a
002	STX	042	"	102	B	142	b
003	ETX	043	#	103	C	143	c
004	EOT	044	\$	104	D	144	d
005	ENQ	045	%	105	E	145	e
006	ACK	046	&	106	F	146	f
007	BEL	047	'	107	G	147	g
010	BS	050	(	110	H	150	h
011	HT	051	)	111	I	151	i
012	LF	052	*	112	J	152	j
013	VT	053	+	113	K	153	k
014	FF	054	,	114	L	154	l
015	CR	055	-	115	M	155	m
016	SO	056	.	116	N	156	n
017	SI	057	/	117	O	157	o
020	DLE	060	0	120	P	160	p
021	DC1	061	1	121	Q	161	q
022	DC2	062	2	122	R	162	r
023	DC3	063	3	123	S	163	s
024	DC4	064	4	124	T	164	t
025	NAK	065	5	125	U	165	u
026	SYN	066	6	126	V	166	v
027	ETB	067	7	127	W	167	w
030	CAN	070	8	130	X	170	x
031	EM	071	9	131	Y	171	y
032	SUB	072	:	132	Z	172	z

<b>Octal Code</b>	<b>Char</b>	<b>Octal Code</b>	<b>Char</b>	<b>Octal Code</b>	<b>Char</b>	<b>Octal Code</b>	<b>Char</b>
033	ESC	073	;	133	[	173	{
034	FS	074	<	134	\	174	
035	GS	075	=	135	]	175	}
036	RS	076	>	136	^	176	~
037	US	077	?	137	_	177	DEL

# Appendix C

## Fill Character Requirements

Fill characters are required to keep the VT100 synchronized with the host computer when the XON/XOFF control codes are not used. Table C-1 shows the VT100 fill character requirements for every receive speed at which the terminal is capable of operating. No entry in a column indicates that fill characters are not required in that specific case.

Receive Baud Rate	Control Function		
	NEL, IND, LF, RI (Smooth scroll feature selected)	DECALN	DECA
19200	384	243	243
9600	192	122	122
4800	96	61	61
2400	48	30	30
2000	40	25	25
1800	36	23	23
1200	24	15	15
600	12	8	8
300	6	4	4
200	4	3	3
150	3	2	2
134.5	3	2	2
110	2	1	1
75	2	1	1
50	1	1	1

Receive Baud Rate	Control Function
	NEL, IND, LF, RI (Smooth scroll feature selected) DECALN DE

Figure 1-1 VT100 Terminal



Figure 1-2 VT100 Keyboard

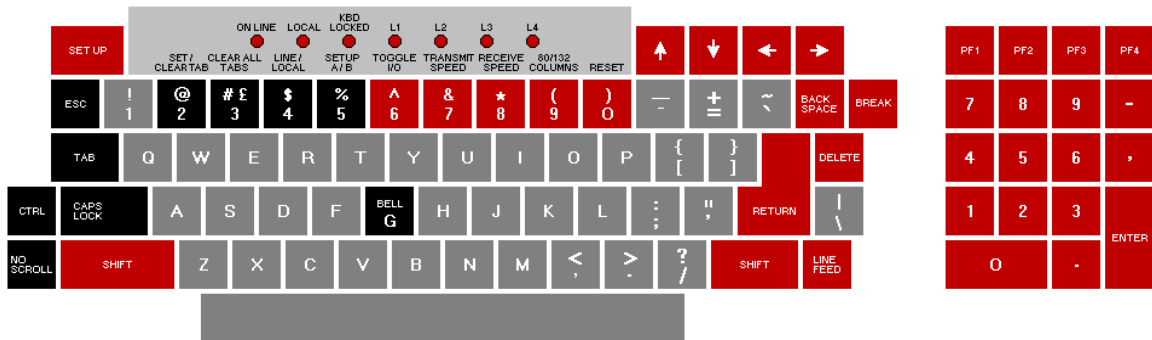

**SETUP**

This key is used in conjunction with other keys to perform specific functions such as setting tabs, scrolling, and altering terminal characteristics.

**ON LINE**

This indicator lights to show that the VT100 is on-line and ready to transmit or receive messages.

**LOCAL**

This indicator lights to show that the terminal is off-line and cannot communicate with the host device. In local mode the keyboard remains active and all characters typed are placed on the screen.



**KEYBOARD LOCKED**



This indicator lights to show that the keyboard has been turned off. The VT100 is still able to receive data from the host. This condition can be cleared by entering and exiting SET-UP mode.

**L1--L4**

These indicators are turned on and off by the host. Consult your local operating procedures for the meaning of each indicator. L1--L4 are also used to show self-test errors.



Each of these keys causes the VT100 to transmit a code which has a special meaning to your system. Consult your local operating procedures for the meaning of these keys. In SET-UP mode the  and  keys increase or decrease the

brightness of the display. The  and  keys move the cursor left and right.



BACKSPACE

This key transmits a backspace code.



BREAK

This key transmits a break signal.



PF1 - PF4

Each of these keys causes the VT100 to transmit a code which has a special meaning to your system. Consult your local operating procedures for the meanings of these keys.

#### Numeric Keypad

The numeric keypad enables numbers to be entered in calculator fashion. Each key in the numeric keypad generates the same character as the corresponding numeric key on the main keyboard. The ENTER key corresponds to the RETURN key. These keys may also be interpreted by the host computer as special function keys. Consult your local operating procedures for the meanings of these keys.



DELETE

This key causes the VT100 to transmit a delete character code to the host system. The deleted character may or may not be erased from the screen.



RETURN

This key transmits either a carriage return (CR) code or a carriage return (CR) and linefeed (LF) code. This is a SET-UP selectable feature.



LINEFEED

This key transmits a linefeed code.



SHIFT

When pressed, this key enables the uppercase function of

all keys. If a key does not have an uppercase function the SHIFT key will be disregarded.



RESET

When the terminal is in SET-UP mode, this key starts the reset sequence. This has the same result as turning the terminal power off and then on.

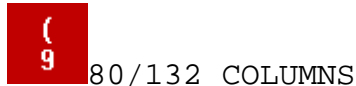

80/132 COLUMNS

When the terminal is in SET-UP A mode, this key switches the display line size from 80 to 132 characters per line or from 132 to 80 characters per line.



RECEIVE SPEED

When the terminal is in SET-UP B mode, this key steps the terminal through the receive baud rate settings in ascending order.



TRANSMIT SPEED

When the terminal is in SET-UP B mode, this key steps the terminal through the transmit baud rate settings in ascending order.



TOGGLE 1/0

When the terminal is in SET-UP B mode, this key turns the selected operational feature on or off.

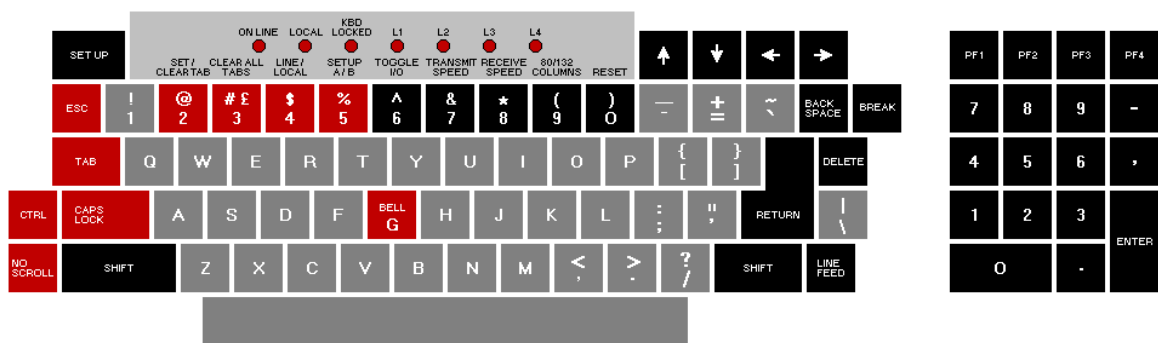

BELL G

When pressed in combination with the CTRL key, this key causes a bell code to be sent to the host.

%  
5

SET-UP A/B

When the terminal is in SET-UP mode, this key switches the terminal from SET-UP A to SET-UP B or from SET-UP B to SET-UP A.

\$  
4

LINE/LOCAL

In SET-UP mode, this key alternately places the VT100 ON LINE or LOCAL to your system. When it is ON LINE, the VT100 communicates with your system. When it is in LOCAL the VT100 is electrically disconnected from your system.

# £  
3

CLEAR ALL TABS

In SET-UP A, this key clears all horizontal tabs set in the VT100.

@  
2

SET/CLEAR TAB

In SET-UP A, this key sets or clears individual horizontal tabs.

CAPS  
LOCK

CAPS LOCK

This key enables the transmission of uppercase alphabetic characters only. All numeric and special symbol keys remain in lowercase.

NO  
SCROLL

NO SCROLL

When first pressed, this key stops the transmission of data from the computer to the VT100. When pressed a second time, transmission resumes from where it was stopped. Check your local operating procedures to ensure that your system recognizes this key.

CTRL

CTRL

When pressed in combination with another key, the CTRL key causes the VT100 to transmit a code which has a special meaning to your system.

TAB

TAB

This key transmits a tab code.



ESC

This key transmits a code which normally has a special meaning to your system. In many applications, it tells your system to treat the next keys pressed as a command.

### Monitor Controls

The VT100 monitor contains only two controls: the power switch and the power selector switch, which is used to adapt the terminal to the available ac input voltage range (see specifications).

### Audible Indicators (Tones)

There are three audible alarms associated with the VT100: a short tone (click), a long tone (bell), and a series of long tones.

Short Tone (Click) -- The short tone is sounded by the terminal whenever a key is pressed, with the following exceptions:

SHIFT or CTRL keys do not generate any keyclick because these keys do not transmit any codes but only modify the codes transmitted by other keys.

KBD LOCKED indicator is turned on; in which case, the characters typed are lost.

The keyclick feature has been turned off in SET-UP mode.

Long Tone (Bell) -- The long tone is sounded by the terminal to indicate one of the following conditions:

A bell code was received from the computer.

The cursor is eight characters away from the right margin and the margin bell feature is enabled.

Series of Long Tones -- The terminal will sound the long tone several times in rapid succession to indicate that the nonvolatile memory (NVR) had difficulty in reading or writing the SET-UP features. (When this occurs, check the SET-UP features and then perform the Recall or Save operation again.)

Unlike most terminals, the VT100 does not use switches or jumpers to individually turn the built-in terminal features on or off. Instead, the VT100 uses a nonvolatile memory (NVR) which always remembers what features have been selected, as if a switch had been set.

The selection and storage of built-in terminal features is performed in a special mode of operation called SET-UP mode. When you enter SET-UP mode, the status of the features stored in the temporary memory is shown on the screen. You can then change the features and store any new feature selections either temporarily, by leaving SET-UP mode; or on a fixed basis, by performing a Save operation. In either case, the terminal operation will reflect the new feature selection. If a recall operation is performed, or the terminal is reset, or the terminal power is turned OFF, all temporary feature settings are replaced by the features that have been stored on a fixed basis.

#### SET-UP Features at a Glance

When entered, SET-UP mode provides two brief summaries of the current feature status. The first presentation -- SET-UP A -- displays the location of the tab stops set in the terminal and a visual ruler which numbers each character position on the line. The second presentation -- SET-UP B -- summarizes the status of the other terminal features.

SET-UP A -- To enter SET-UP A, press the SET-UP key. The display will now have a presentation similar to Figure 1-4. The bottom line of the display consists of a "ruler" which numbers each character position available on a line. The location of each tab stop is shown by a "T" placed above the ruler. If the tab stop(s) set are those desired, you may exit SET-UP mode by pressing the SET-UP key again or you may now change the tabs to meet your requirements.

SET-UP B -- SET-UP B mode may only be entered from SET-UP A mode. To enter SET-UP B from SET-UP A, press the 5 key on the main keyboard. The display will then look like Figure 1-5.

Figure 1-6 summarizes the SET-UP B presentation. This summary allows you to quickly determine what features are enabled. For additional information on a feature refer to the Definition of Each Feature section.

To exit SET-UP B press the SET-UP key.

## Determining What a SET-UP Feature Does

The SET-UP features are basically a series of options in the VT100 that allow the terminal to be tailored to its operating environment. Table 1-1 lists each feature and places it in one or more of the following general categories:

Installation

Computer compatibility

Operator comfort

The installation category concerns itself with the initial installation of the terminal and any special options that may be attached to the terminal. If any terminal options are added or removed, or the physical location of the installation is changed, verify the settings of these SET-UP features.

Computer compatibility contains the features which must be set correctly so that the VT100 can communicate with the host computer. An error in these settings may cause incorrect data to be sent to or received from the computer; or an error may prevent the VT100 from communicating with the computer. The settings for these features must be obtained from the host computer programmer, operator, or system manager since there are many combinations of settings designed to work with particular computers and special software. These feature settings would normally change only when you need to communicate with a different computer or a unique software package.

The operator comfort category contains the SET-UP features designed exclusively for the operator. These features allow the operator to tailor the VT100 to fit individual preference. These features do not affect any operations that occur between the terminal and the computer.



The next section, Definition of Each SET-UP Feature, describes the specific function of each feature.

### How To Change a SET-UP Feature

Changing any or all of the SET-UP features is a simple operation and is generally performed by following the same basic steps.

Enter SET-UP mode by pressing the SET-UP key

Select the appropriate SET-UP mode by pressing the 5 key on the main keyboard each time you want to switch from SET-UP A to SET-UP B or from SET-UP B to SET-UP A.

Position the cursor above the feature switch or tab stop to be changed. To position the cursor, the SPACEBAR, , , TAB and RETURN keys may be used. Some features do not use this step since a specific key is dedicated to changing the feature.

Change the feature setting by pressing either the 6 key on the main keyboard or the appropriate dedicated key. Each time the key is pressed the feature will change, generally to the opposite state.

Table 1-2 briefly summarizes the SET-UP features, the SET-UP mode you must be in to change a given feature, and the key used to change the feature setting.

#### Setting the Answerback Message

Setting the answerback message is different from setting any of the other terminal features. An answerback message can be typed into the VT100, using the following steps:

Place the terminal in SET-UP B mode.

Press the SHIFT and A key simultaneously. The terminal will respond by placing A = on the screen. (The SHIFT key is required. The CAPS LOCK key will not work here.)

Type the message delimiter character which may be any character not used in the actual answerback message. The message delimiter character is not a part of the answerback message. If a mistake is made when typing the answerback message, type the message delimiter character again and go back to step 2. This is the only way to correct errors in the answerback message.

Type the answerback message. The message may be up to 20 characters, including space and control characters. Control characters will be displayed as a  character to indicate their presence in the message.

Type the message delimiter character. Once the message delimiter character is typed the answerback message will disappear from the screen.

Once the above steps have been completed the answerback message will be temporarily stored in the VT100 and can be saved with the Save operation.

#### Saving the SET-UP Features

SET-UP features may be changed and stored on either a temporary or a fixed basis. To temporarily store a feature, exit SET-UP mode after changing the feature; the terminal now reacts according to the new setting. If a recall operation is performed, or the terminal is reset, or the terminal power is turned off, all temporary feature settings are replaced by the features that have been stored on a fixed basis.

To store SET-UP feature settings on a fixed basis, perform a save operation. This is a simple operation that is accomplished by performing the following steps:

Place the terminal in SET-UP mode.

Press the SHIFT and S keys simultaneously. The screen will clear and the message "wait" will be displayed in the upper-left corner. After a brief wait, the terminal will return to SET-UP A mode.

NOTE: The save operation must be performed at the terminal keyboard. The computer cannot perform this operation, although it can temporarily modify the settings of some VT100 features.

Once these steps have been performed, SET-UP features which had been temporarily stored will now be stored on a fixed basis.

#### Recalling SET-UP Features

The temporarily stored SET-UP feature settings may differ from the settings which have been stored on a fixed basis. If you wish to return to the fixed settings, perform the recall operation as follows:

Place the terminal in SET-UP mode.

Press the SHIFT and R keys simultaneously. The screen will clear and the message "wait" will appear in the upper-left corner of the screen. After a brief wait the terminal will return to SET-UP A mode.

NOTE: When a recall operation is performed the contents of the screen are destroyed.

### Resetting the Terminal

The VT100 may be reset from the keyboard. When the terminal is reset, the terminal memory is cleared and the self-test program is run as if the terminal power switch had been turned OFF and then back ON. To reset the terminal:

Place the terminal in SET-UP mode.

Press the 0 key on the main keyboard. The VT100 will be reset, the power on self-test will be run, and the terminal will set according to the fixed SET-UP features.

NOTE: When a reset operation is performed the contents of the screen are destroyed and any options present may be affected.

### Part 3 -- Definition of Each SET-UP Feature

This section describes each SET-UP feature in detail (in alphabetical order) and states how each feature affects the terminal.

NOTE: Unless otherwise stated, entering SET-UP mode and changing features does not result in the loss of data displayed on the screen.

#### ANSI/VT52 Mode

The VT100 terminal follows two different programming standards -- American National Standards Institute (ANSI) and VT52. In ANSI mode, the VT100 will generate and respond to coded sequences per ANSI standards X3.41-1974 and X3.64-1977. In VT52 mode, the VT100 terminal is compatible with previous DIGITAL software using the VT52 video terminal. Both ANSI and VT52 modes are outlined in the programmer's section of this manual.

#### ANSWERBACK Message

Answerback is a question and answer sequence where the host computer asks the terminal to identify itself. The VT100 answerback features provides the terminal with the capability to identify itself by sending a message to the host. The entire answerback sequence takes place automatically without affecting the screen or requiring operator action. The answerback message may also be transmitted by typing CTRL-BREAK.

#### AUTO REPEAT

The auto repeat feature allows a key to be automatically repeated at the rate of about 30 characters per second when the key is held down for more than one-half second. The auto repeat feature affects all keyboard keys except the following:

SET-UP

ESC

NO SCROLL

TAB

RETURN

CTRL and any key

#### AUTO XON/XOFF

The VT100 is capable of automatically generating synchronizing codes XON (DC1) and XOFF (DC3). The XOFF code is used to stop the transmission of data from the computer to the terminal; the XON code is used to resume transmission. With the feature enabled, the VT100 will generate the XOFF code when one of the following events occur:

The internal buffer is nearly full

The NO SCROLL key is pressed

The terminal is placed in SET-UP mode

CTRL-S is pressed.

NOTE: The VT100 will always stop transmission when an XOFF (DC3) code is received and will resume transmission when an XON (DC1) code is received regardless of the AUTO XON/XOFF feature setting.

When either the buffer empties, the NO SCROLL key is pressed again, the terminal is taken out of SET-UP mode, or CTRL-Q is pressed, the VT100 will transmit the XON code to resume transmission from the computer to the terminal.

If the host computer software does not support the XON/XOFF codes, data sent during buffer full conditions, or when the terminal is in SET-UP mode, may be lost.

#### BITS PER CHARACTER

This feature allows the terminal to transmit and receive either 7- or 8-bit characters. When set for 8-bit operation, bit 8 is set to a space (or 0) for characters transmitted and is ignored for all characters received.

#### CHARACTERS PER LINE

The VT100 is capable of displaying either 80 or 132 characters per line. In the 80 character per line mode, the screen is 80 characters wide by 24 lines high. In the 132 character per line mode, the screen is 132 characters wide by 14 lines high (24 lines if the VT100 is equipped with the Advanced Video Option). In the 132 character per line mode, the displayed lines are physically the same width as in the 80 character per line mode but the characters are more compact.

NOTE: When changing from 80 to 132 character per line mode or vice-versa, the current contents of the screen are lost.

The use of double-width characters reduces the number of characters per line by half.

#### CURSOR

The VT100 offers a choice of two cursor representations to indicate the "active position", or where the next character will be placed on the screen. The cursor may be displayed as either a blinking underline (    ) or a blinking block ( **█** ). The cursor selection may perform an additional function; see the SGR escape sequence definition in Chapter 3.

#### INTERLACE

This feature is used for high resolution options. To reduce screen flicker the interlace feature should be turned off if such an option is not installed.

#### KEYCLICK TONE

The keyclick is a tone which is generated every time a code transmitting key is pressed. The keyclick may be turned on or off to suit the operator's needs. However, research and experience has shown that an operator is more accurate when there is an audible feedback from the keyboard.

Like the bell tone, the keyclick volume is not adjustable.

#### LINE/LOCAL

The LINE/LOCAL feature allows the operator to easily

place the terminal in either an ON-LINE or a LOCAL (off-line) condition. When the terminal is on-line (the keyboard ON-LINE indicator is ON) all characters typed on the keyboard are sent directly to the computer and messages from the computer are displayed on the screen. In the LOCAL condition (the keyboard LOCAL indicator is ON), the terminal is electrically disconnected from the computer; messages are not sent to or received from the computer; and characters typed on the keyboard are echoed on the screen directly.

#### MARGIN BELL

The margin bell feature is much the same as the bell in a typewriter. If the cursor is eight characters from the end of the current line while typing, the VT100 sounds a tone to alert the operator.

#### NEW LINE

The new line feature enables the RETURN key on the terminal to function like the RETURN key on an electric typewriter. When the new line feature is enabled, pressing the RETURN key generates the carriage return (CR) and line feed (LF) codes. When a line feed code is received, the code is interpreted as a carriage return and line feed.

NOTE: If double line feeds occur consistently, turn this feature off since the computer is already performing this function automatically.

When the new line feature is disabled, the RETURN key generates only the CR code; an LF code causes the terminal to perform a line feed only.

#### PARITY

Parity, when enabled, checks for correct data transmission. If a transmission error occurs, the VT100 can detect it and indicate its presence by placing a checkerboard character (⏏) on the screen in place of the character with the error. The parity sense feature determines if the parity is even or odd. When parity is disabled, no parity bit is transmitted or received.

NOTE: If the parity feature is turned off, the parity sense selection will be disregarded.

#### PARITY SENSE

The parity sense feature defines which of the two methods of parity checking, odd or even, is being used by the VT100. If the parity feature is on, the terminal's parity sense must be matched to the parity the computer is

sending. If the parity sense features do not match, most characters sent to the computer will be rejected even though the character was received correctly by the VT100.

If a parity incompatibility occurs, the checkerboard character (⌘) will be shown on the screen in place of the received character.

#### POWER

During the initial installation, the terminal display must be set to the power line frequency. In the U.S. this is set to 60 hertz.

#### RECEIVE SPEED

The receive speed must be set to match the computer transmit speed. The VT100 is capable of receiving at any one of the following preselected speeds: 50, 75, 110, 134.5, 150, 200, 300, 600, 1200, 1800, 2000, 2400, 3600, 4800, 9600, 19,200 baud.

#### SCREEN BACKGROUND

The screen background feature of the VT100 allows the operator to determine the background of the screen. In the normal screen mode, the display contains light characters on a dark background; in the reverse screen mode, the display contains dark characters on a light background.

#### SCREEN BRIGHTNESS

Unlike most video terminals, the VT100 does not contain switches or knobs to adjust screen brightness. Instead, the VT100 electronically controls the screen brightness.

This feature eliminates the high failure rate of mechanical controls and still allows the operator to select the desired level of brightness for maximum comfort under varied lighting conditions. This setting may be saved like any other feature in the terminal.

#### SCROLL

Scrolling the upward or downward movement of existing lines on the screen to make room for new lines at the bottom or top of the screen. It can be performed in two ways: jump scroll or smooth scroll. In jump scroll mode, new lines appear on the screen as fast as the computer sends them to the terminal. At the higher baud rates, the data is very difficult to read due to the rapid movement of the lines. In smooth scroll mode, a limit is placed on the speed at which new lines of data may be sent to the terminal. The movement of lines occurs at a smooth steady rate allowing the data to be read as it appears on the screen.

NOTE: Smooth scroll mode allows a maximum of six lines of data per second to be added to the screen. The Auto XON/XOFF feature must be enabled and supported by the host computer to ensure that data is not lost when smooth scroll mode is enabled.

#### TABS

Just like a typewriter, the VT100 can jump or tab to preselected points on a line. These tab stops may be individually changed, or totally cleared and then set.

#### TRANSMIT SPEED

Transmit speed must be set to match the computer receive speed. The VT100 is capable of transmitting at any one of the following preselected transmit speeds: 50, 75, 110, 134.5, 150, 200, 300, 600, 1200, 1800, 2000, 2400, 3600, 4800, 9600, and 19,200 baud.

Transmit speed is independent of receive speed; the terminal may transmit data at one speed and receive data at a different speed.

#### WRAPAROUND

When this feature is enabled, the 81st or 133rd character (depending upon the line size selected) inserted on a line is automatically placed in the first character position of the next line. If the wraparound feature was not enabled, the 81st or 133rd character and all following characters would be overwritten into the last character position of the current line.

NOTE: The use of double-width characters reduces the number of characters per line by half.

# £

3

(shifted)

The VT100 contains character sets for the U.S. and the United Kingdom. The difference between the two character sets is one character, the # or £ symbol. When the standard U.S. character set is selected, the uppercase 3 key on the main keyboard displays the # character. The £ character is displayed when the U.K. character set is selected.

#### Part 4 -- Self-Testing the VT100

A self-test mode is built into the VT100 that automatically, or on command, tests the condition of the terminal should a fault be suspected. The self-test program checks the following items:

Advanced Video Memory (if option is installed)

Nonvolatile Memory (NVR)

Internal Memory

Keyboard

This test is performed automatically whenever the terminal is turned on.

Self-Test Error Codes

There are two broad categories of errors: fatal and nonfatal.

Fatal errors cause the terminal to immediately stop all operations. No intelligible information is displayed on the screen; however, the screen most likely contains a random pattern of characters. The only error indication (in addition to the random characters) is a possible error code displayed on the programmable keyboard LEDs, L1--L4; however, no terminal function, including the lighting of LEDs, is guaranteed if a fatal error is found.

NOTE: The loopback and EIA modem control tests are not performed on power-up; they must be invoked separately with the proper escape sequence. See the programmer's section for further information on these tests.

Nonfatal errors do not halt the terminal processor. Instead, the terminal is forced to LOCAL mode and an error code character is displayed in the upper-left corner of the screen.

There are five types of nonfatal errors:

(AVO) Advanced Video Option data RAM

(NVR) Nonvolatile data RAM checksum error

(KBD) Keyboard missing or malfunction

(Data) Data loopback error

(EIA) EIA modem control error

Table 1-3 shows the possible nonfatal error characters that may appear on the screen and the failure represented by each character.

#### Part 5 -- What To Do in the Event of a Problem

If it appears that there is a problem in the terminal, you should initiate the power-up self-test program. This test will help to determine if the problem lies in your terminal or in some other part of the computer system. Table 1-4 describes the items an operator can check prior to making a service call.

Figure 1-3 VT100 Terminal (Rear View)

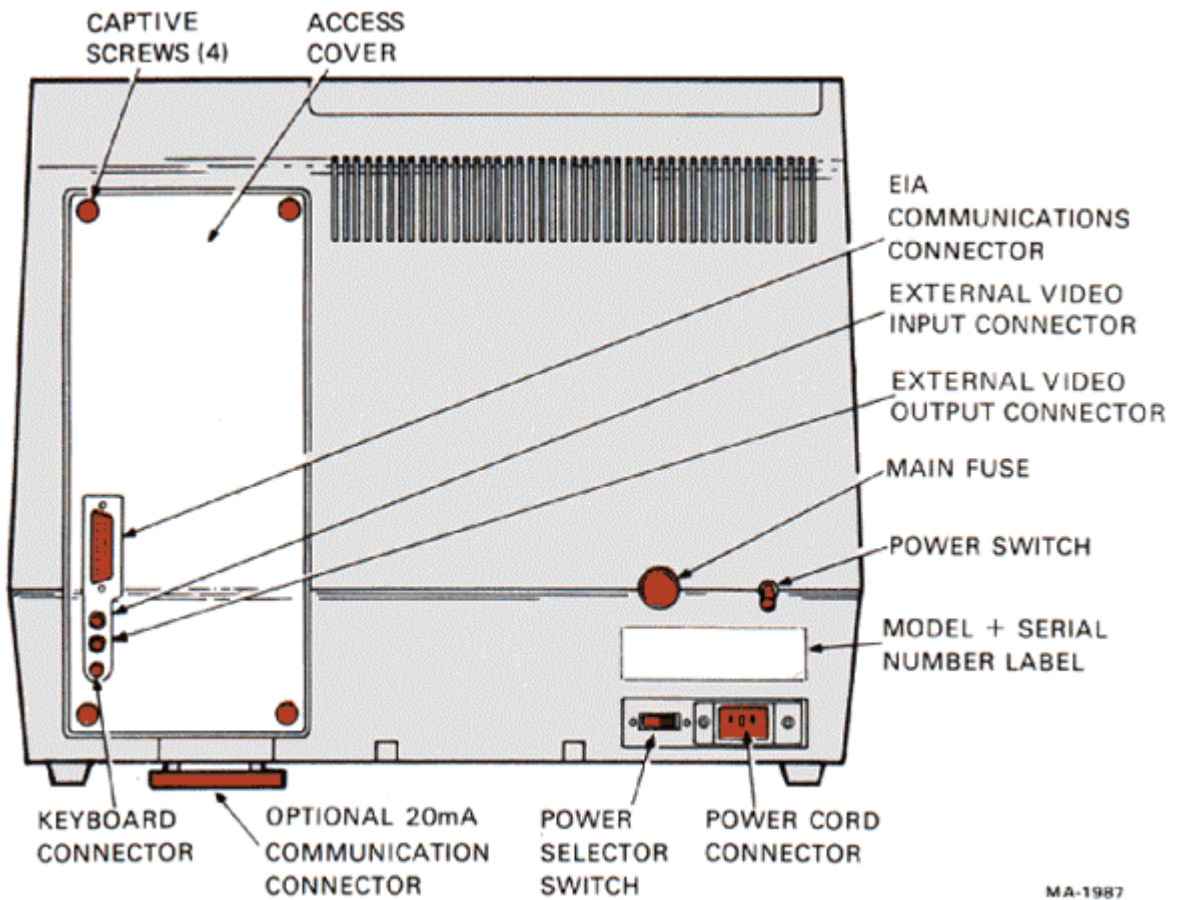

Figure 1-4 SET-UP A Mode Presentation

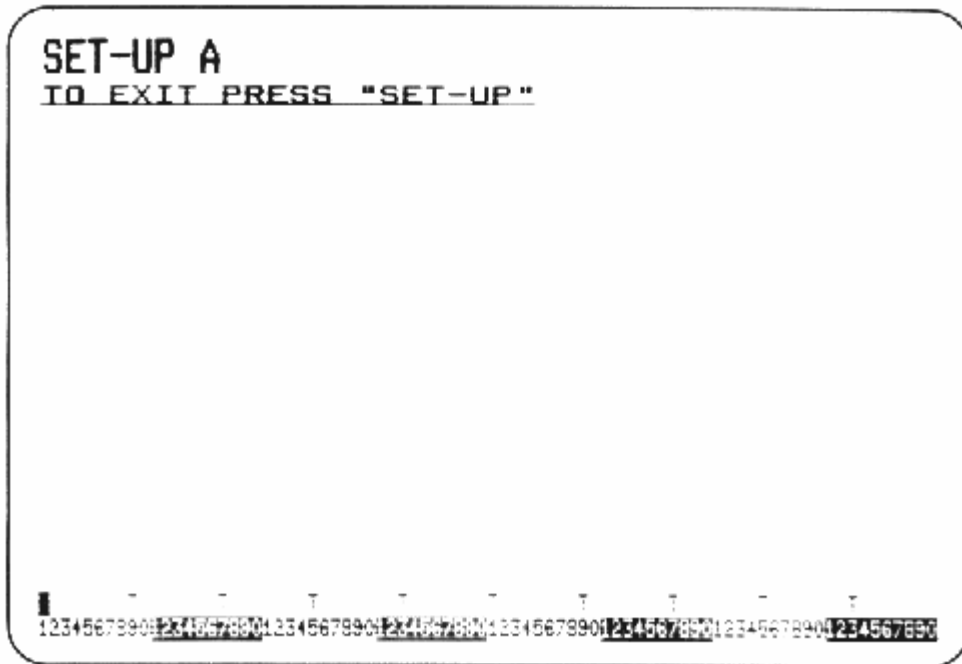

Figure 1-5 SET-UP B Mode Presentation

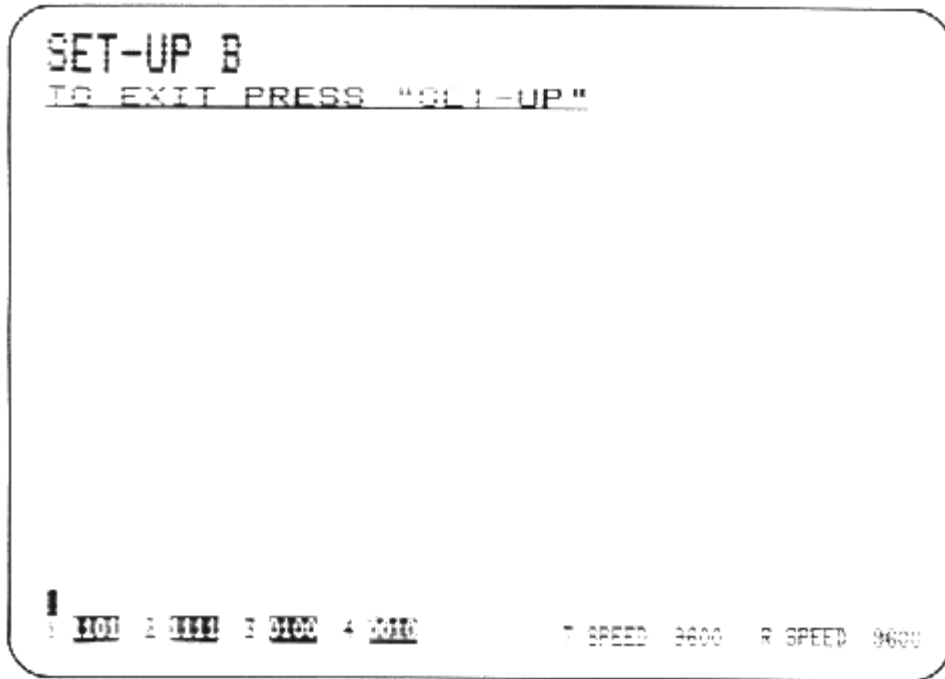

Figure 1-6 SET-UP B Mode Summary

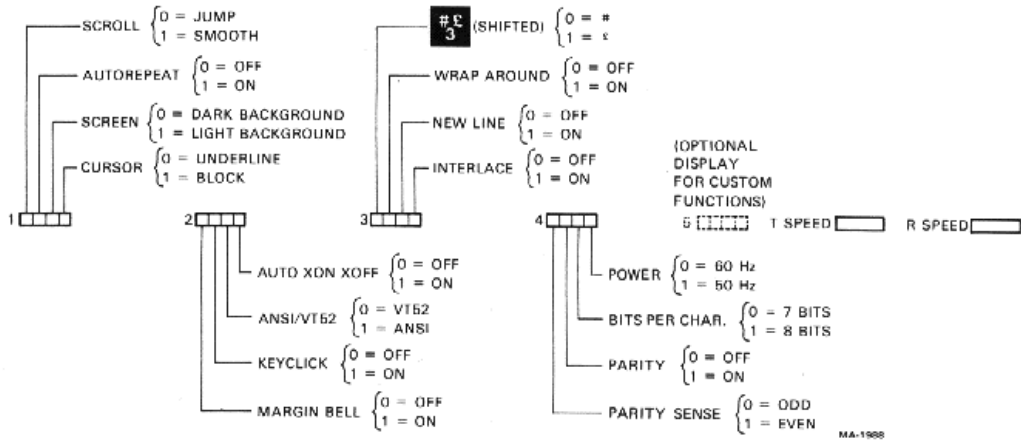
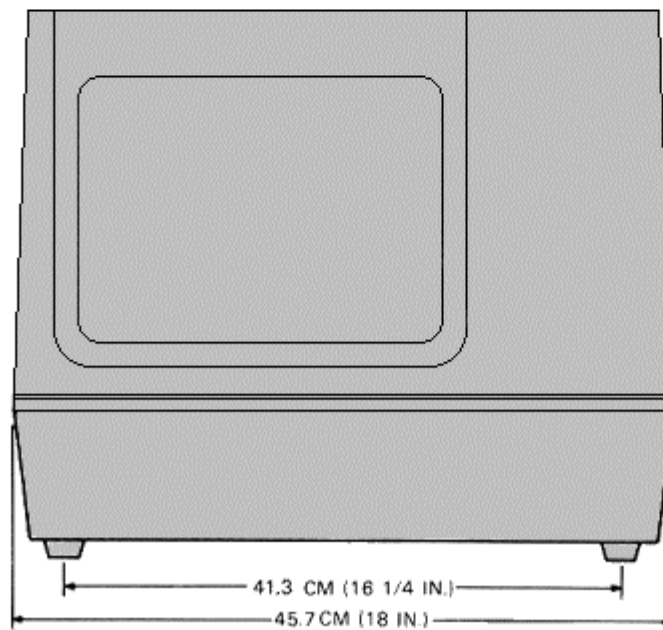
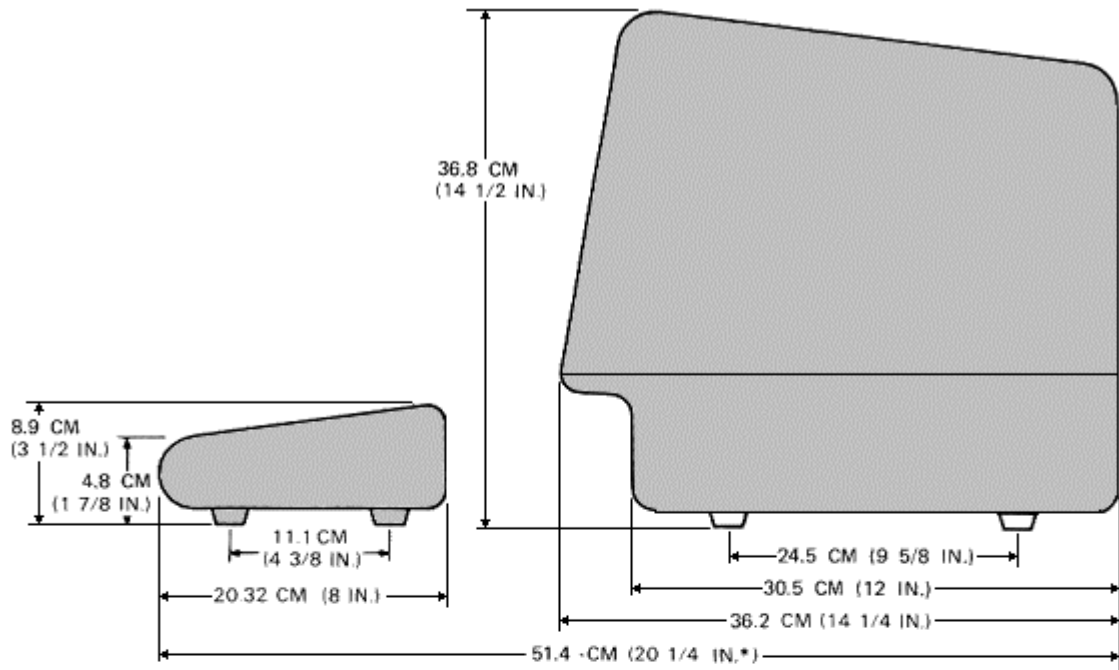

Figure 2-1 VT100 Terminal Dimensions



\* MEASUREMENT TAKEN WITH THE KEYBOARD PLACED FLUSH TO FRONT OF TERMINAL UNDER UNDERCUT.

Figure 2-2 VT100 Rear View

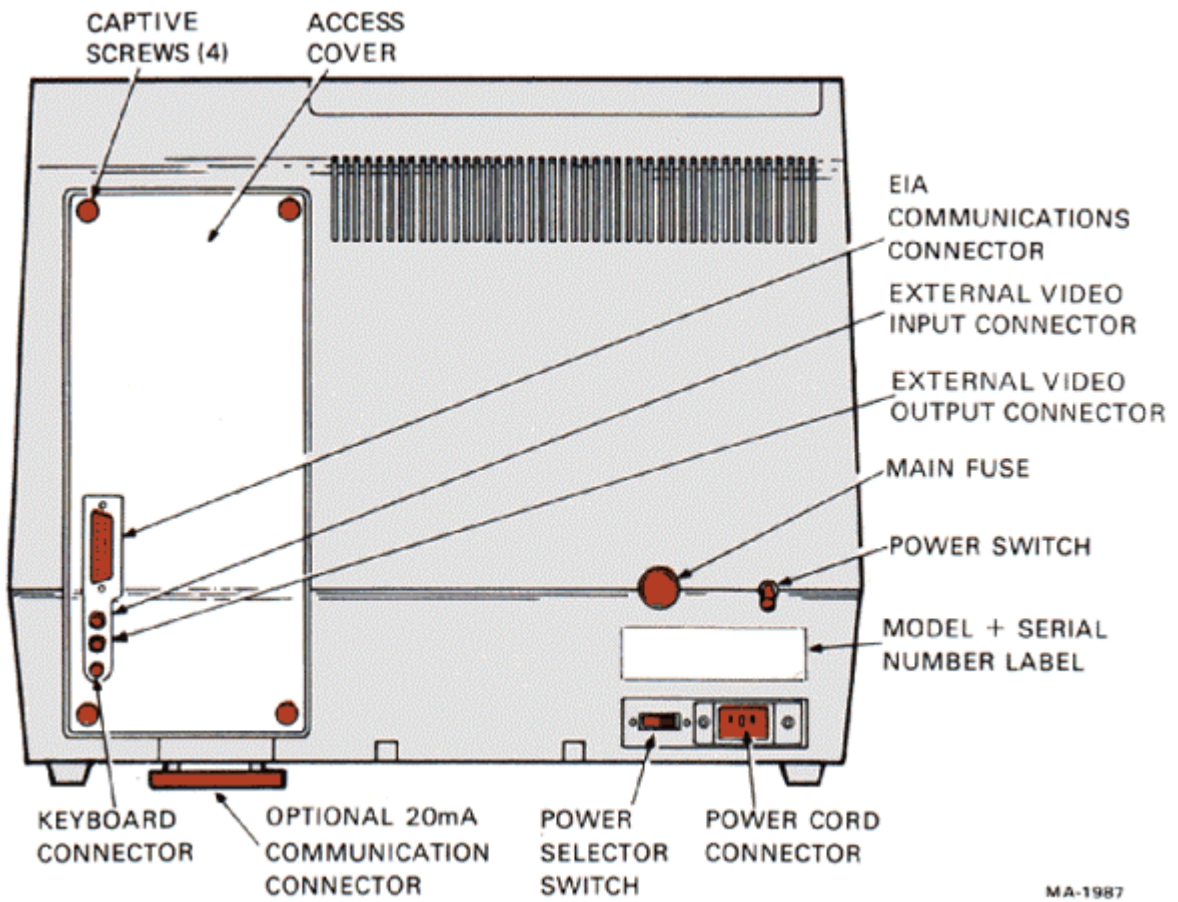

Figure 2-3 20 mA Current Loop Interface

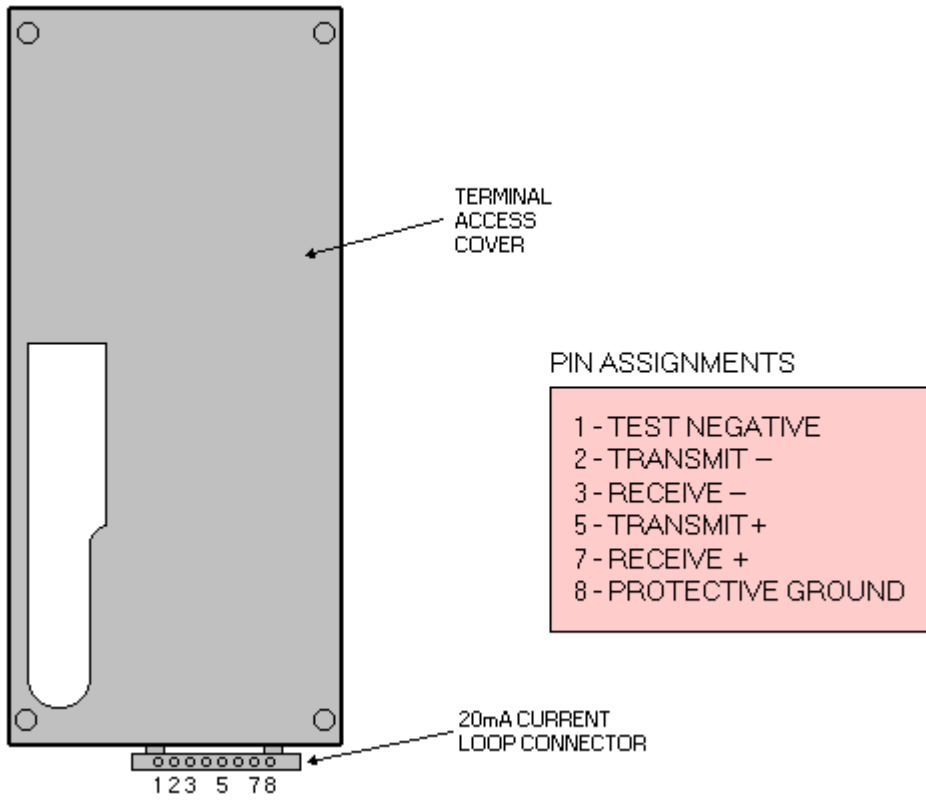
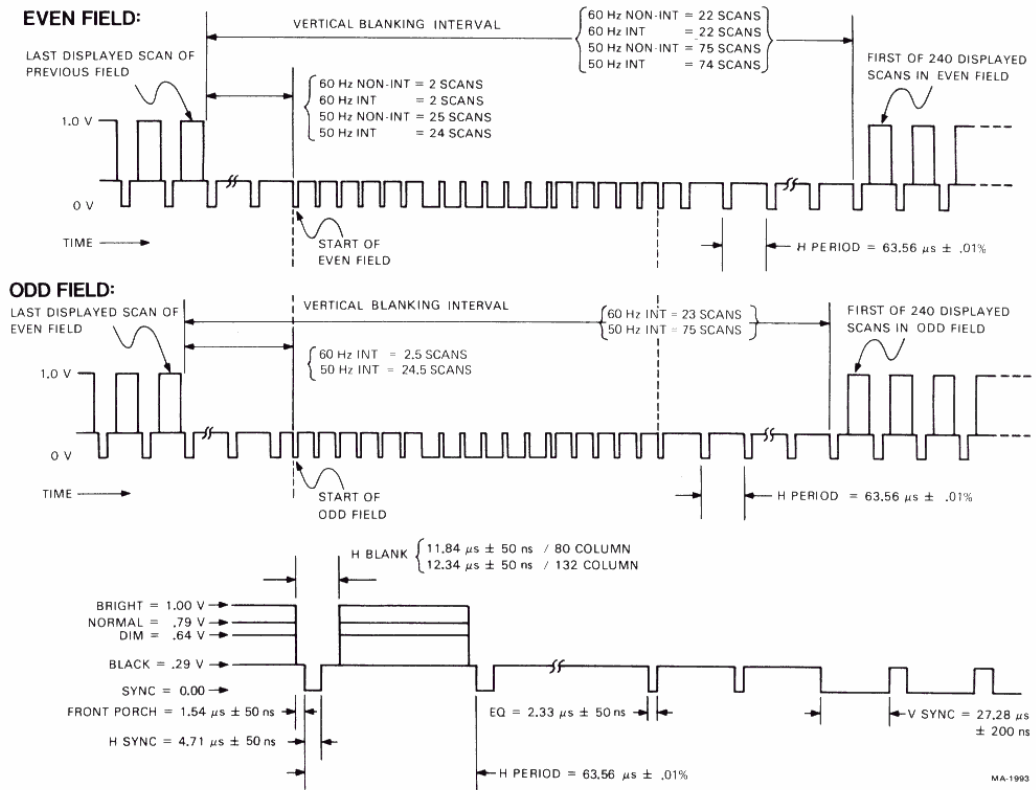

Figure 2-4 Composite Video Output



NOTES:

- IN NON-INTERLACED OPERATION THE EVEN FIELD IS REPEATED CONTINUOUSLY, AND THE ODD FIELD IS NOT USED
- IN THE INTERLACED OPERATION THE EVEN FIELD ALTERNATES WITH THE ODD FIELD
- ALL FIELDS CONTAIN 240 DISPLAYED SCANS.

Figure 2-4  
Composite Video Output

Figure 3-1 Terminal Data Flow

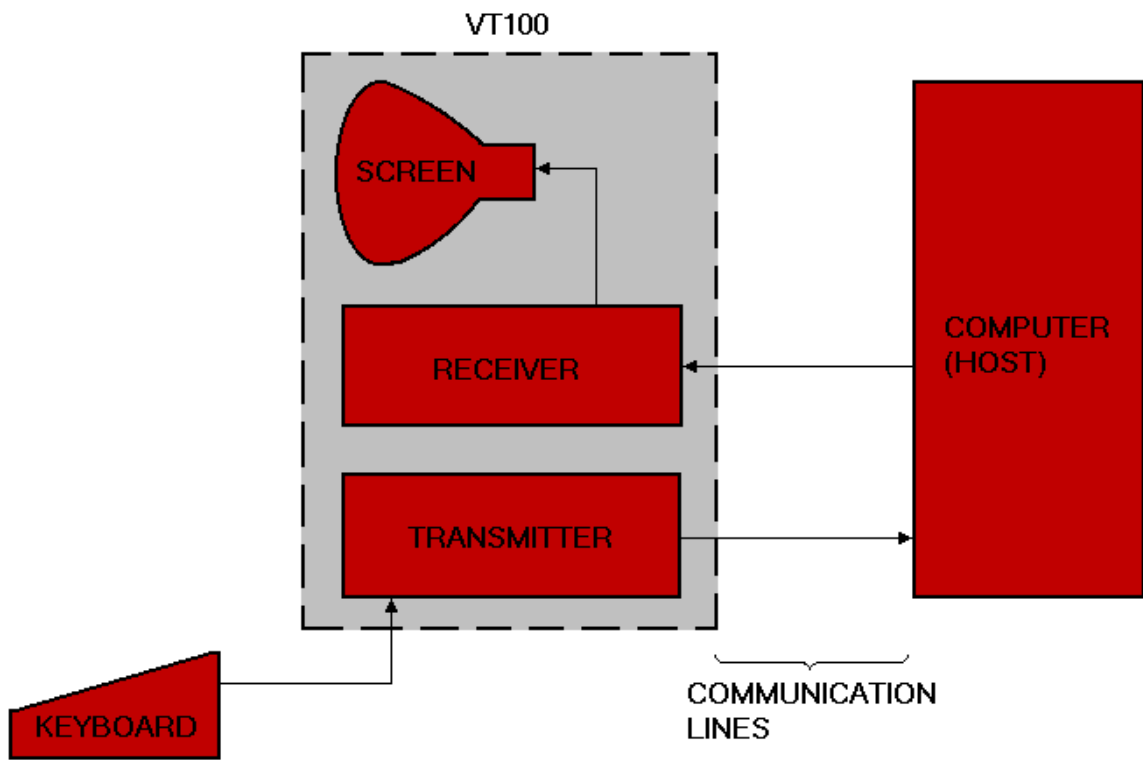

Figure 3-2 VT100 Keyboard

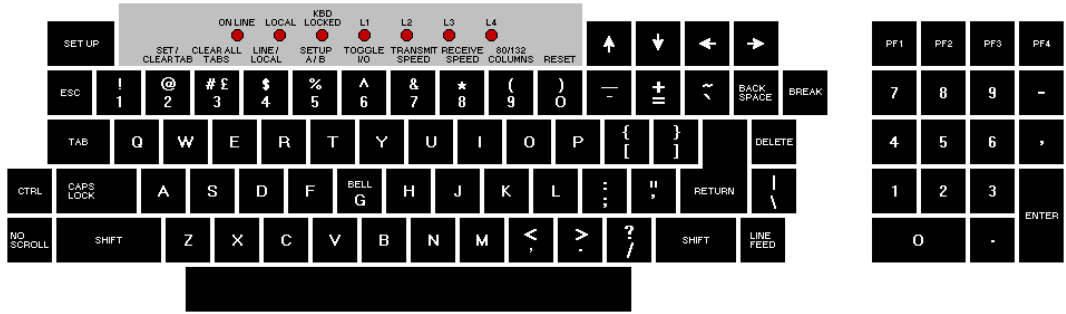

Figure 4-1 VT100 Rear View

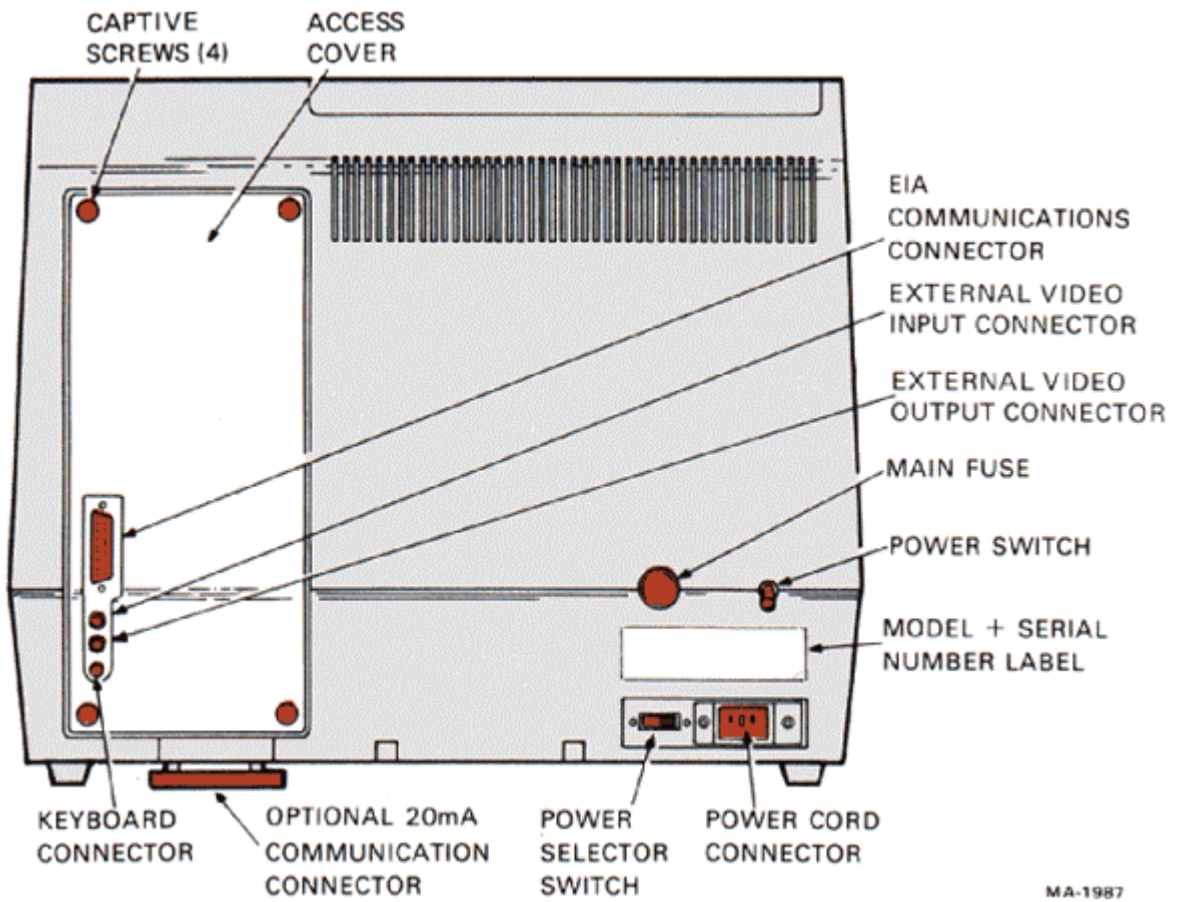

Figure 4-2 Advanced Video Option Installation

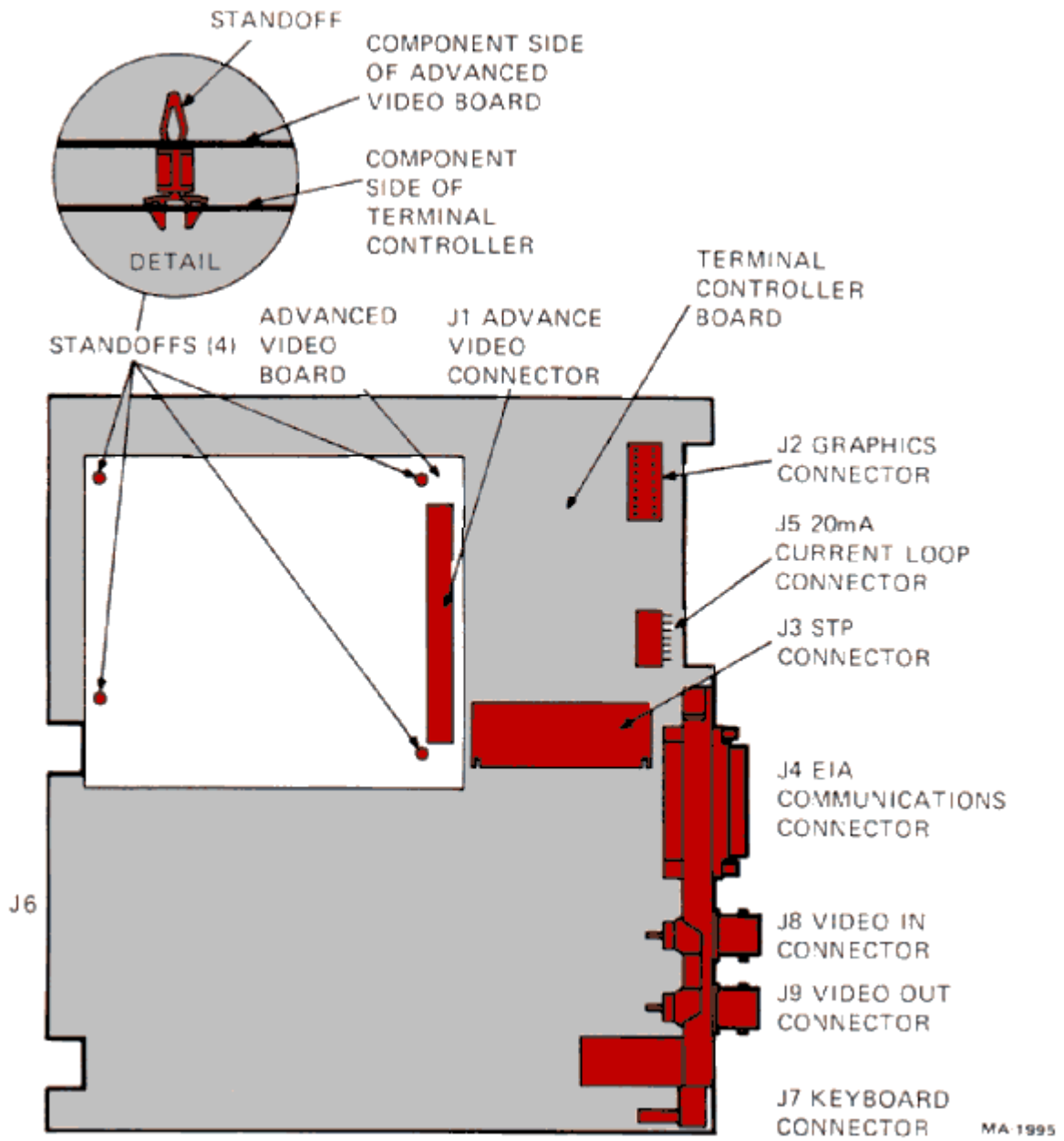

Figure 4-3 20 mA Current Loop Option

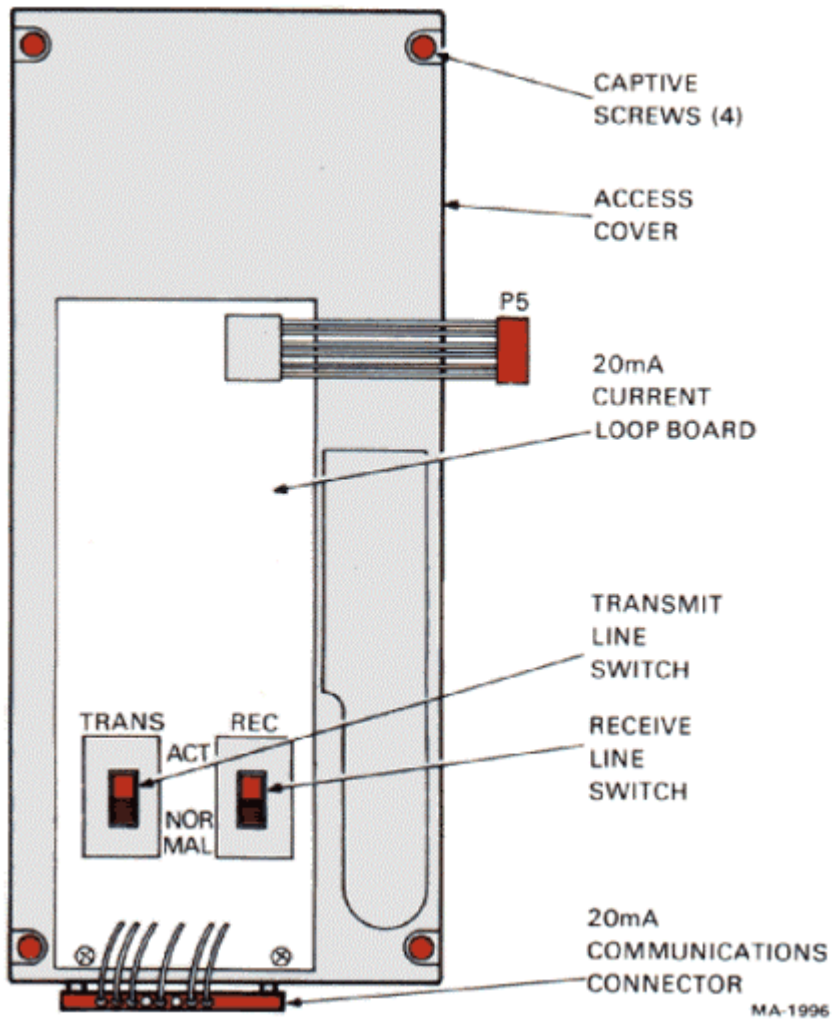

Figure 4-4 Terminal Controller Board

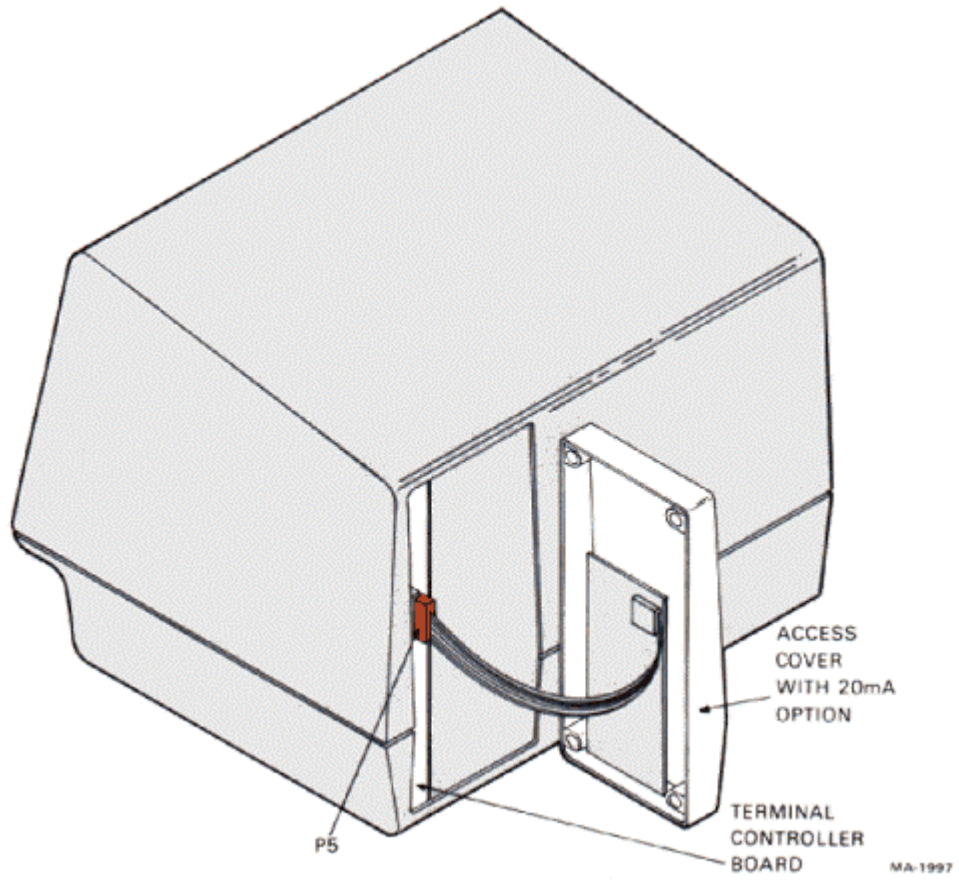

Table 1-1 Categories of SET -UP Features

SET-UP Feature	Installation	Computer Compatibility	Operator Comfort
ANSI/VT52 Mode		X	
ANSWERBACK Message		X	
AUTO REPEAT			X
AUTO XON XOFF		X	
BITS PER CHARACTER		X	
CHARACTERS PER LINE		X	
CURSOR			X
INTERLACE	X		
KEYCLICK			X
LINE/LOCAL		X	
MARGIN BELL			X
NEW LINE		X	
PARITY		X	
PARITY SENSE		X	
POWER	X		
RECEIVE SPEED		X	
SCREEN BACKGROUND			X
SCREEN BRIGHTNESS			X
SCROLL		X	
TABS		X	
TRANSMIT SPEED		X	
WRAPAROUND		X	
# £ 3 (shifted)		X	

Table 1-2 SET-UP Feature Change Summary

SET-UP Feature	Changed In		Key Used to Change Feature	SET-UP Feature	Changed In		Key Used to Change Feature
	SET-UP A Mode	SET-UP B Mode			SET-UP A Mode	SET-UP B Mode	
ANSI/VT52 Mode		X	<b>^ 6</b>	PARITY		X	<b>^ 6</b>
ANSWERBACK Message		X	†	PARITY SENSE		X	<b>^ 6</b>
AUTO REPEAT		X	<b>^ 6</b>	POWER		X	<b>^ 6</b>
AUTO XON XOFF		X	<b>^ 6</b>	RECEIVE SPEED		X	<b>* 8</b>
BITS PER CHARACTER		X	<b>^ 6</b>	SCREEN BACKGROUND		X	<b>^ 6</b>
CHARACTERS PER LINE	X		<b>( 9</b>	SCREEN BRIGHTNESS	X	X	<b>↑</b> or <b>↓</b>
CURSOR		X	<b>^ 6</b>	SCROLL		X	<b>^ 6</b>
INTERLACE		X	<b>^ 6</b>	TABS	X		<b>@ 2</b> and <b># £ 3</b>
KEYCLICK		X	<b>^ 6</b>	TRANSMIT SPEED		X	<b>&amp; 7</b>
LINE/LOCAL	X	X	<b>\$ 4</b>	WRAPAROUND		X	<b>^ 6</b>
MARGIN BELL		X	<b>^ 6</b>	<b># £ 3</b> (shifted)		X	<b>^ 6</b>
NEW LINE		X	<b>^ 6</b>				

† A special sequence is required for this feature

Table 1-3 Nonfatal Displayed Error Codes

Character Displayed	Fault Detected					Character Displayed	Fault Detected				
	AVO	NVR	KBD	Data	EIA		AVO	NVR	KBD	Data	EIA
1	X					@					X
2		X				A	X				X
3	X	X				B		X			X
4			X			C	X	X			X
5	X		X			D			X		X
6		X	X			E	X		X		X
7	X	X	X			F		X	X		X
8				X		G	X	X	X		X
9	X			X		H				X	X
:		X		X		I	X			X	X
;	X	X		X		J		X		X	X
<			X	X		K	X	X		X	X
=	X		X	X		L			X	X	X
>		X	X	X		M	X		X	X	X
?	X	X	X	X		N		X	X	X	X
						O	X	X	X	X	X

Table 1-4 Problem Checklist

Symptom	Possible Cause and Corrective Action
VT100 will not turn ON when the power switch is set to ON.	<p>AC power cord is not plugged into wall outlet; plug in cord.</p> <p>AC power cord is not plugged into the terminal; plug in cord.</p> <p>Power is not coming from the wall outlet; check outlet with a known working electrical device (such as a lamp). If no power, call your electrician.</p> <p>AC line fuse blown; turn terminal OFF and have the fuse replaced. (See <a href="#">Figure 1-3</a> for location).</p>
No keyboard response	<p>Keyboard cable not plugged into monitor; plug in keyboard cable.</p> <p>KBD LOCKED indicator on; computer has turned the keyboard off. The KBD LOCKED conditions may be cleared by entering and exiting the SET-UP mode. If this condition persists, check with the host computer software people for a possible operating error.</p> <p>Perform the self-test operation.</p>
Garbled or Error Characters 	<p>Incorrect SET-UP feature selection; correct the SET-UP features.</p> <p>Suggested SET-UP features which may be in error:</p> <ul style="list-style-type: none"> <li>• ANSI/VT52 mode</li> <li>• Auto XON/XOFF</li> <li>• Bits per character</li> <li>• Parity</li> <li>• Parity sense</li> <li>• Receiver speed</li> <li>• Transmit speed</li> </ul> <p>Perform the self-test operation.</p>
Several successive long tones	<p>The terminal has had difficulty in reading or writing the SET-UP features stored in non-volatile memory. Check the feature settings and perform the save operation.</p> <p>Perform the self-test operation.</p>

Table 2-1 EIA RS-232-C Connector Signals

Pin Number	Description	Pin Number	Description
1	Protective ground	14	(not used)
2	Transmitted data	15	Transmit clock
3	Received data	16	(not used)
4	Request to send	17	Receive clock
5	Clear to send	18	(not used)
6	Data set ready	19	Speed select (secondary request to send)
7	Signal ground (common return)	20	Data terminal ready
8	Carrier detect	21	(not used)
9	(not used)	22	Ring indicator
10	(not used)	23	Same as pin 19
11	Same as pin 19	24	(not used)
12	Speed indicator (secondary carrier detect)	25	(not used)
13	(not used)		

Table 3-1 Machine States

SET-UP Feature or Machine State	Changeable from Host Computer*	Saved in NVR and Changeable in SET-UP
Alternate keypad mode	Yes (DECKPAM/DECKPNM)	No
ANSI/VT52	Yes (DECANM)	Yes
Auto Repeat	Yes (DECARM)	Yes
AUTO XON XOFF	No	Yes
Bits per character	No	Yes
Characters per line	Yes (DECCOLM)	Yes
Cursor	No	Yes
Cursor key modes	Yes (DECCKM)	No
Interlace	Yes (DECINLM)	Yes
New Line	Yes (LNM)	Yes
Keyclick	No	Yes
Margin bell	No	Yes
Origin mode	Yes (DECOM)	No
Parity	No	Yes
Parity sense	No	Yes
Power	No	Yes
Receive speed	No	Yes
Screen	Yes (DECSCNM)	Yes
Scroll	Yes (DECSCLM)	Yes
Tabs	Yes (HTS/TBC)	Yes
Transmit speed	No	Yes
Wraparound	Yes (DECAWM)	Yes
 (shifted)	Yes (SCS)	Yes

Table 3-2 Alphabetic Key Codes

<b>Key</b>	<b>Uppercase Code (octal)</b>	<b>Lowercase Code (octal)</b>	<b>Key</b>	<b>Uppercase Code (octal)</b>	<b>Lowercase Code (octal)</b>
A	101	141	N	116	156
B	102	142	O	117	157
C	103	143	P	120	160
D	104	144	Q	121	161
E	105	145	R	122	162
F	106	146	S	123	163
G	107	147	T	124	164
H	110	150	U	125	165
I	111	151	V	126	166
J	112	152	W	127	167
K	113	153	X	130	170
L	114	154	Y	131	171
M	115	155	Z	132	172

Table 3-3 Nonalphabetic Key Codes

Lowercase Character	Neither SHIFT Key Down (Octal)	Uppercase Character	Either or Both SHIFT Keys Down (Octal)
1	061	!	041
2	062	@	100
3	063	# or £	043
4	064	\$	044
5	065	%	045
6	066	^	136
7	067	&	046
8	070	*	052
9	071	(	050
0	060	)	051
-	055	_	137
=	075	+	053
[	133	{	173
;	073	:	072
' (apostrophe)	047	"	042
, (comma)	054	<	074
. (period)	056	>	076
/	057	?	077
\	134		174
`	140	~	176
]	135	}	175

Table 3-4 Function Key Codes

<b>Key</b>	<b>Octal Value of Code Sent or Received by VT100</b>	<b>Action The Terminal Would Take If Host Sent That Code</b>
<b>RETURN</b>	015	Carriage return function
<b>LINEFEED</b>	012	Line Feed
<b>BACKSPACE</b>	010	Backspace function
<b>TAB</b>	011	Tab function
<b>SPACE BAR</b>	040	Deposit a space on the screen erasing what was there before.
<b>ESC</b>	033	The initial delimiter of an escape sequence – interpret the following character string from the host as a command, rather than displaying it.
<b>DELETE</b>	177	Ignored by the VT100

\* The RETURN key can be redefined so that it issues 015<sub>8</sub>, 012<sub>8</sub>, (carriage return – line feed). The New Line feature in SET-UP mode provides this capability.



Table 3-5 Control Codes Generated

<b>Key Pressed with CTRL key down (shifted or unshifted)</b>	<b>Octal Code Transmitted</b>	<b>Function Mnemonic</b>	<b>Key Pressed wwith CTRL key down (shifted or unshifted)</b>	<b>Octal Code Transmitted</b>	<b>Function Mnemonic</b>
Space Bar	000	NUL	P	020	DLE
A	001	SOH	Q	021	DC1 or XON
B	002	STX	R	022	DC2
C	003	ETX	S	023	DC3 or XOFF
D	004	EOT	T	024	DC4
E	005	ENQ	U	025	NAK
F	006	ACK	V	026	SYN
G	007	BELL	W	027	ETB
H	010	BS	X	030	CAN
I	011	HT	Y	031	EM
J	012	LF	Z	032	SUB
K	013	VT	[	033	ESC
L	014	FF	\	034	FS
M	015	CR	]	035	GS
N	016	SO	~	036	RS
O	017	SI	?	037	US

Table 3-6 Cursor Control Key Codes

<b>Cursor Key (Arrow)</b>	<b>VT52 Mode*</b>	<b>ANSI Mode and Cursor Key Mode Reset*</b>	<b>ANSI Mode and Cursor Key Mode Set</b>
Up	ESC A	ESC [ A	ESC O A
Down	ESC B	ESC [ B	ESC O B
Right	ESC C	ESC [ C	ESC O C
Left	ESC D	ESC [ D	ESC O D

\* See the control sequences section of this chapter for a complete discussion of these modes.

Table 3-7 VT52 Mode Auxiliary Keypad Codes

Key	Keypad Numeric Mode	Keypad Application Mode	Key	Keypad Numeric Mode	Keypad Application Mode
0	0	ESC ? p	-(dash)	-(dash)	ESC ? m
1	1	ESC ? q	, (comma)	, (comma)	ESC ? l*
2	2	ESC ? r	.(period)	.(period)	ESC ? n
3	3	ESC ? s	ENTER	Same as RETURN	
4	4	ESC ? t		key	ESC ? M
5	5	ESC ? u	PF1	ESC P	ESC P
6	6	ESC ? v	PF2	ESC Q	ESC Q
7	7	ESC ? w	PF3	ESC R	ESC R
8	8	ESC ? x	PF4	ESC S	ESC S
9	9	ESC ? y			

\* The last character of this escape sequence is a lowercase L (154<sub>8</sub>).

Table 3-8 ANSI Mode Auxiliary Keypad Codes

Key	Keypad Numeric Mode	Keypad Application Mode	Key	Keypad Numeric Mode	Keypad Application Mode
0	0	ESC O p	-(dash)	-(dash)	ESC O m
1	1	ESC O q	, (comma)	, (comma)	ESC O l*
2	2	ESC O r	.(period)	.(period)	ESC O n
3	3	ESC O s	ENTER	Same as RETURN	
4	4	ESC O t		key	ESC O M
5	5	ESC O u	PF1	ESC O P	ESC O P
6	6	ESC O v	PF2	ESC O Q	ESC O Q
7	7	ESC O w	PF3	ESC O R	ESC O R
8	8	ESC O x	PF4	ESC O S	ESC O S
9	9	ESC O y			

\* The last character of the escape sequence is a lowercase L (154<sub>8</sub>).

*NOTE: In ANSI mode, if the codes are echoed back to the VT100, or if the terminal is in local mode, the last character of the sequence will be displayed on the screen; e.g., PF1 will display a "P".*

Table 3-9 Special Graphics Characters

Octal Code	Graphic with US or UK Set	Graphic with "Special Graphics" Set	Octal Code	Graphic with US or UK Set	Graphic with "Special Graphics" Set
137	_	Blank	157	o	Horizontal line - Scan 1
140	`	Diamond	160	p	Horizontal line - Scan 3
141	a	Checkerboard (error indicator)	161	q	Horizontal line - Scan 5
142	b	Horizontal tab	162	r	Horizontal line - Scan 7
143	c	Form Feed	163	s	Horizontal line - Scan 9
144	d	Carriage return	164	t	Left "T"
145	e	Line feed	165	u	Right "T"
146	f	° Degree symbol	166	v	Bottom "T"
147	g	± Plus/minus	167	w	Top "T"
150	h	New line	170	x	Vertical bar
151	i	Vertical tab	171	y	Less than or equal to
152	j	Lower-right corner	172	z	Greater than or equal to
153	k	Upper-right corner	173	{	Pi
154	l	Upper-left corner	174		Not equal to
155	m	Lower-left corner	175	}	UK pound sign
156	n	Crossing lines	176	~	Centered dot

Note 1: Codes 152<sub>8</sub>-156<sub>8</sub>, 161<sub>8</sub>, and 164<sub>8</sub>-170<sub>8</sub> are used to draw rectangular grids; each piece of this line drawing set is contiguous with others so that the lines formed are unbroken.

Note 2: Codes 157<sub>8</sub>-163<sub>8</sub> give better vertical resolution than dashes and underlines when drawing graphs; using these segments 120 × 132 resolution may be obtained in 132 column mode with the Advanced Video Option installed.

Table 3-10 Control Characters

Control Character	Octal Code	Action Taken
NUL	000	Ignored on input (not stored in input buffer; see full duplex protocol).
ENQ	005	Transmit answerback message.
BEL	007	Sound bell tone from keyboard.
BS	010	Move the cursor to the left one character position, unless it is at the left margin, in which case no action occurs.
HT	011	Move the cursor to the next tab stop, or to the right margin if no further tab stops are present on the line.
LF	012	This code causes a line feed or a new line operation. (See new line mode).
VT	013	Interpreted as LF.
FF	014	Interpreted as LF.
CR	015	Move cursor to the left margin on the current line.
SO	016	Invoke G1 character set, as designated by SCS control sequence.
SI	017	Select G0 character set, as selected by ESC ( sequence.
XON	021	Causes terminal to resume transmission.
XOFF	023	Causes terminal to stop transmitted all codes except XOFF and XON.
CAN	030	If sent during a control sequence, the sequence is immediately terminated and not executed. It also causes the error character to be displayed.
SUB	032	Interpreted as CAN.
ESC	033	Invokes a control sequence.
DEL	177	Ignored on input (not stored in input buffer).

# Appendix C

## Fill Character Requirements

Fill characters are required to keep the VT100 synchronized with the host computer when the XON/XOFF control codes are not used. Table C-1 shows the VT100 fill character requirements for every receive speed at which the terminal is capable of operating. No entry in a column indicates that fill characters are not required in that specific case.

Receive Baud Rate	Control Function							
	NEL, IND, LF, RI (Smooth scroll feature selected)	DECALN	DECCOLM	ED	NEL, IND, LF, RI (Jump scroll feature selected)	EL	DECINLM	All others except DECTST and RIS
19200	384	243	243	90	60	4	2	2
9600	192	122	122	45	30	2	1	1
4800	96	61	61	23	15	1	1	
2400	48	30	30	11	7			
2000	40	25	25	9	6			
1800	36	23	23	9	6			
1200	24	15	15	6	4			
600	12	8	8	3	2			
300	6	4	4	1	1			
200	4	3	3	1	1			
150	3	2	2	1				
134.5	3	2	2	1				
110	2	1	1	1				
75	2	1	1					
50	1	1	1					